

# BELL

**Switzerland**

**Austin Healey, MG,  
Rover, Triumph,  
Jaguar**

**Line Drawings**

**WEST-CLASSIC**



**WEST - Classic**

**[www.west-classic.ch](http://www.west-classic.ch) / [www.west-motoren.ch](http://www.west-motoren.ch)**

**e-mail: [west-classic@hotmail.com](mailto:west-classic@hotmail.com)**

**8353 Elgg bei Winterthur**

**Tel: +41 52 213 14 13**



STAINLESS STEEL EXHAUSTS

West-Classic Tel: 0041 213 14 13 e-mail [west-classic@hotmail.com](mailto:west-classic@hotmail.com) Web: [www.west-classic.ch](http://www.west-classic.ch) / [www.west-motoren.ch](http://www.west-motoren.ch)

AUSTIN HEALEY PAGE 1-6

JAGUAR PAGE 7-30

MG PAGE 31-66

ROVER PAGE 67-83

TRIUMPH PAGE 84-114



STAINLESS STEEL EXHAUSTS

West-Classic Tel: 0041 213 14 13 e-mail [west-classic@hotmail.com](mailto:west-classic@hotmail.com) Web: [www.west-classic.ch](http://www.west-classic.ch) / [www.west-motoren.ch](http://www.west-motoren.ch)

# AUSTIN HEALEY

## SPRITE MKI & MKII 1959-64 / MIDGET MKI 1961 - 64

FRONT PIPE  
SILENCER AND TAIL PIPE

BS AN 056  
BS AN 219

**SYSTEM NUMBER**

**BSS-AH-001**

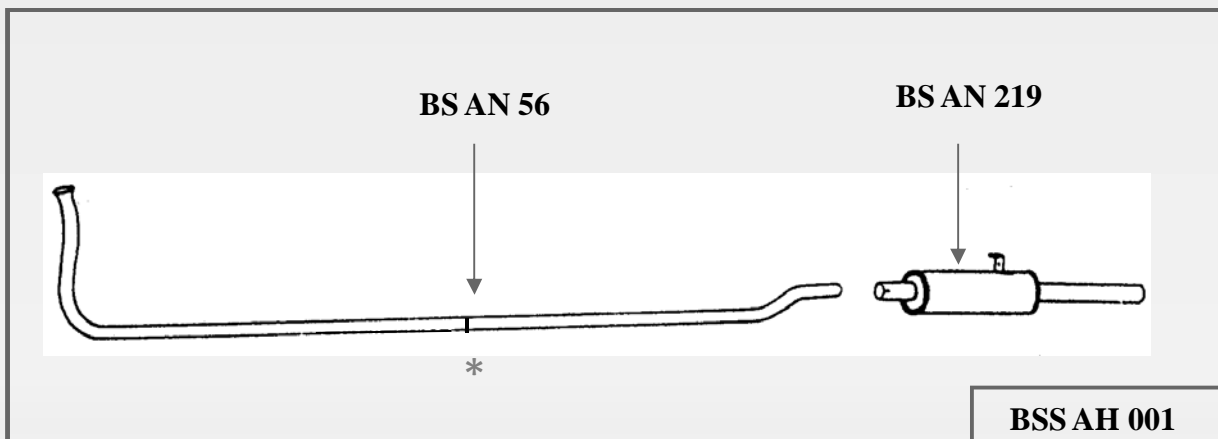

**\* Part No. BS AN 56 is now supplied in two sections with a clamp for the joint.**



**BS AN 219**





STAINLESS STEEL EXHAUSTS

West-Classic Tel: 0041 213 14 13 e-mail [west-classic@hotmail.com](mailto:west-classic@hotmail.com) Web: [www.west-classic.ch](http://www.west-classic.ch) / [www.west-motoren.ch](http://www.west-motoren.ch)

# AUSTIN HEALEY

## SPRITE MKIII 1964 – 66 / MIDGET MKII & MKIII 1964-69

FRONT PIPE  
SILENCER AND TAIL PIPE

BS AN 290  
BS AN 233

SYSTEM NUMBER

BSS-AH-003

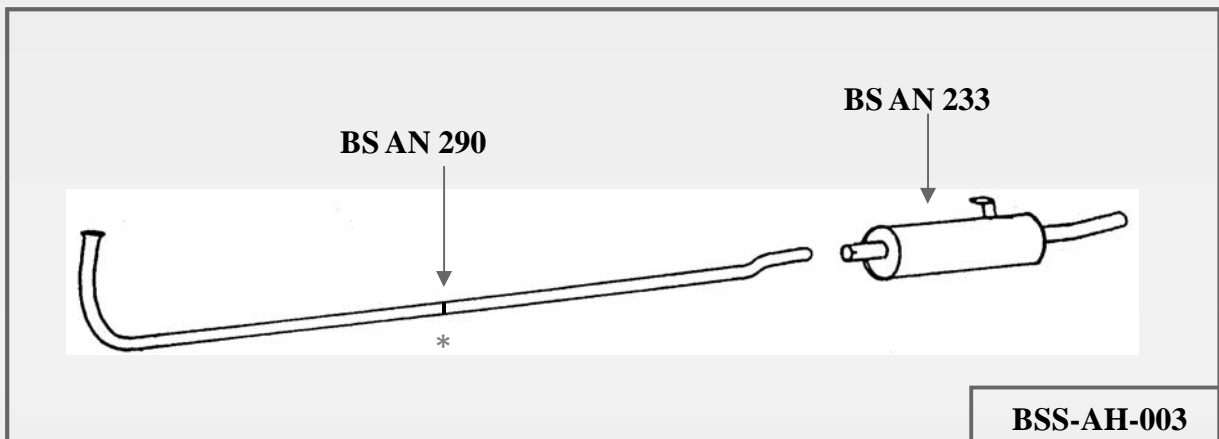

\* Part No. BS AN 290 is now supplied in two sections with a clamp for the joint.



BS AN 233





STAINLESS STEEL EXHAUSTS

West-Classic Tel: 0041 213 14 13 e-mail [west-classic@hotmail.com](mailto:west-classic@hotmail.com) Web: [www.west-classic.ch](http://www.west-classic.ch) / [www.west-motoren.ch](http://www.west-motoren.ch)

# AUSTIN HEALEY

## SPRITE MK IV 1966 – 71 / MIDGET MKII & III 1970-75

FRONT PIPE  
TWIN SILENCER

BS AN 290  
BS AN 336

SYSTEM NUMBER

BSS-AH-004

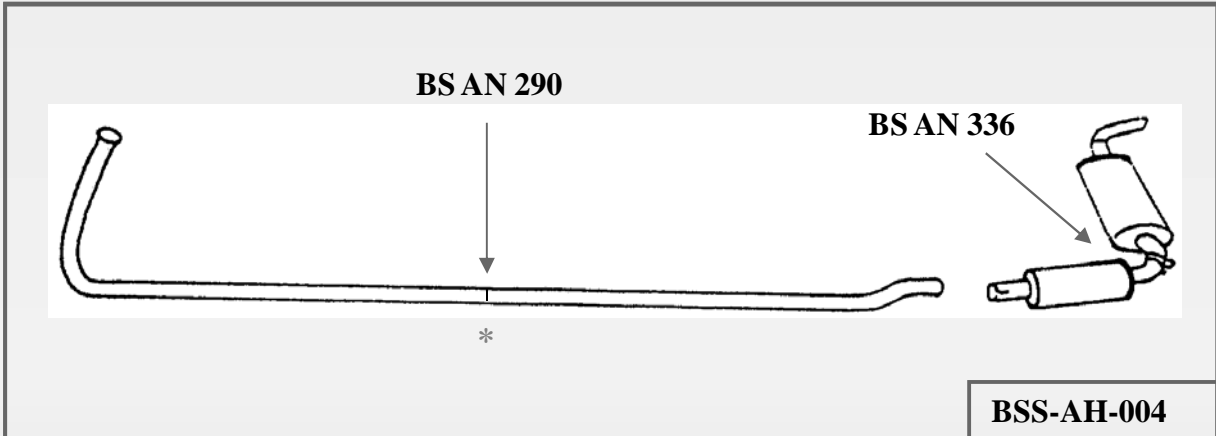

**\* Part No. BS AN 290 is now supplied in two sections with a clamp for the joint.**



**BS AN 336**





**STAINLESS STEEL EXHAUSTS**

West-Classic Tel: 0041 213 14 13 e-mail [west-classic@hotmail.com](mailto:west-classic@hotmail.com) Web: [www.west-classic.ch](http://www.west-classic.ch) / [www.west-motoren.ch](http://www.west-motoren.ch)

**AUSTIN HEALEY**

**100/4 1953-56 / BN1 & BN2**

FRONT FLEX PIPE  
SILENCER  
TAIL PIPE

BS AH 001P  
BS AH 002P  
BS AH 003P

**SYSTEM NUMBER**

**BSS-AH-005P**

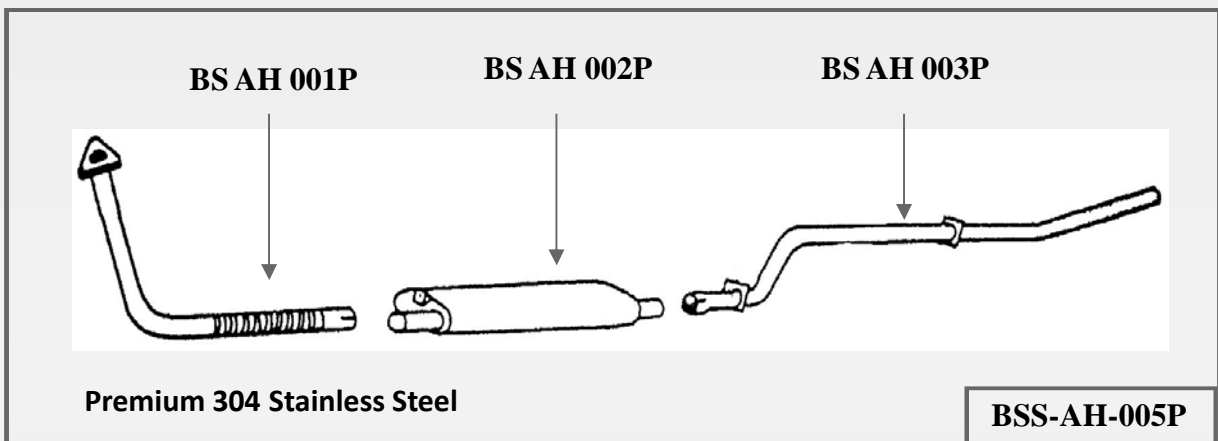

**BS AH 001P**



**BS AH 002P**

MANUFACTURED IN THE UK BY EXPERIENCED HIGHLY SKILLED CRAFTSMAN





**STAINLESS STEEL EXHAUSTS**

West-Classic Tel: 0041 213 14 13 e-mail [west-classic@hotmail.com](mailto:west-classic@hotmail.com) Web: [www.west-classic.ch](http://www.west-classic.ch) / [www.west-motoren.ch](http://www.west-motoren.ch)

**AUSTIN HEALEY**

**100/6 1956-64 / BN4 TO BJ7**

FRONT PIPE LH  
FRONT PIPE RH  
SILENCER  
TWIN TAIL PIPES

BS AH 004P  
BS AH 005P  
BS AH 006P  
BS AH 007P

**SYSTEM NUMBER**

**BSS-AH-006P**

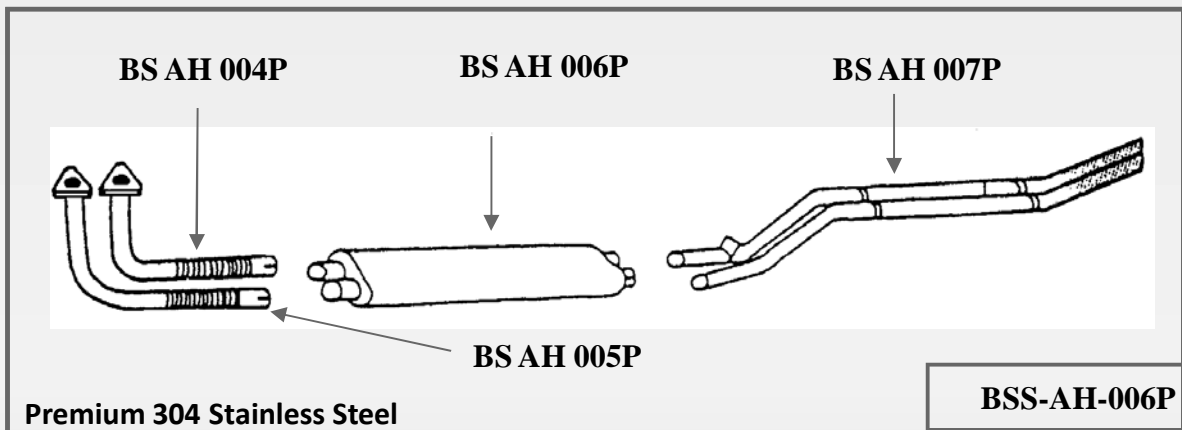

**BS AH 007P**





**STAINLESS STEEL EXHAUSTS**

West-Classic Tel: 0041 213 14 13 e-mail [west-classic@hotmail.com](mailto:west-classic@hotmail.com) Web: [www.west-classic.ch](http://www.west-classic.ch) / [www.west-motoren.ch](http://www.west-motoren.ch)

**AUSTIN HEALEY**

**3000 MK3 1964-65 / BJ8**

- 3000 MKIII OUT FRONT PIPE
- 3000 MKIII INNER FRONT PIPE
- 3000 MKIII OUTER BOX
- 3000 MKIII INNER BOX
- 3000 MKIII REAR BOX RH
- 3000 MKIII REAR BOX LH

- BS AH 008P
- BS AH 009P
- BS AH 010P
- BS AH 011P
- BS AH 012P
- BS AH 013P

**SYSTEM NUMBER**

**BSS-AH-006P**

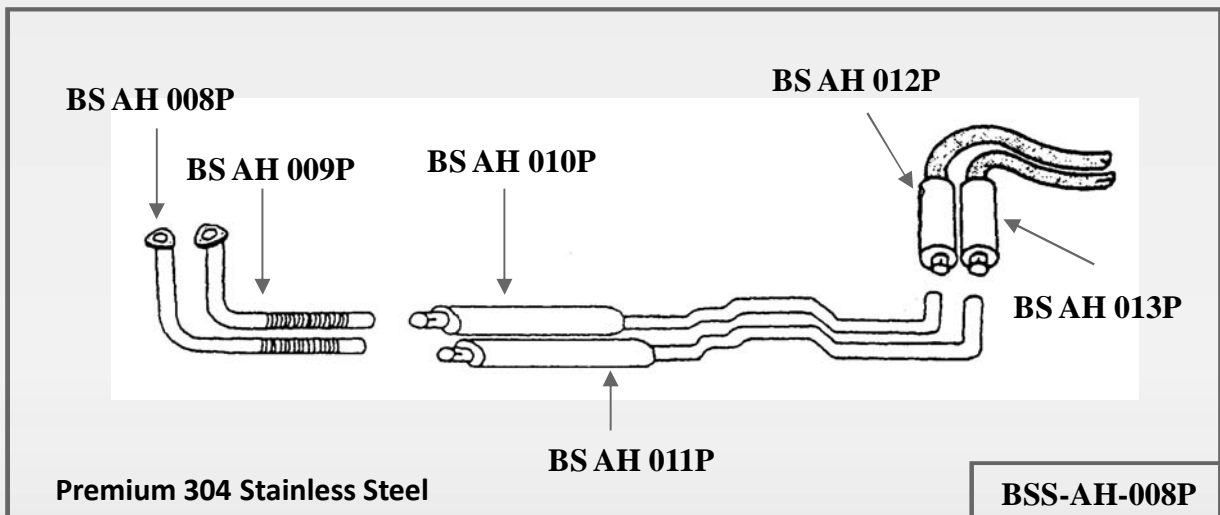



# JAGUAR

## CONTENTS

<b>PAGE 8-10</b>	<b>XK 120/140</b>
<b>PAGE 11</b>	<b>MKI &amp; MKII 2.4</b>
<b>PAGE 12-13</b>	<b>MKII 3.4 &amp; 3.8 240 SALOON</b>
<b>PAGE 14</b>	<b>340 SALOON SOVEREIGN</b>
<b>PAGE 15</b>	<b>DAIMLER 2.5 V8</b>
<b>PAGE 16</b>	<b>DAIMLER DS &amp; MK10</b>
<b>PAGE 17-19</b>	<b>E TYPE 6CYL</b>
<b>PAGE 20-21</b>	<b>E TYPE V12</b>
<b>PAGE 22-25</b>	<b>XJ6 COUPE</b>
<b>PAGE 26 -28</b>	<b>XJ6 SALOON</b>
<b>PAGE 29</b>	<b>XJS HE SER. 2 &amp; 3</b>

# JAGUAR

## XK 120/140 SINGLE SYSTEM RHD ONLY (1950 -1954)

TWIN FRONT PIPE  
SILENCER  
TAIL PIPE

BS JR 30  
BS JR 31  
BS JR 32P

**SYSTEM NUMBER**

**BSS-JR-001**

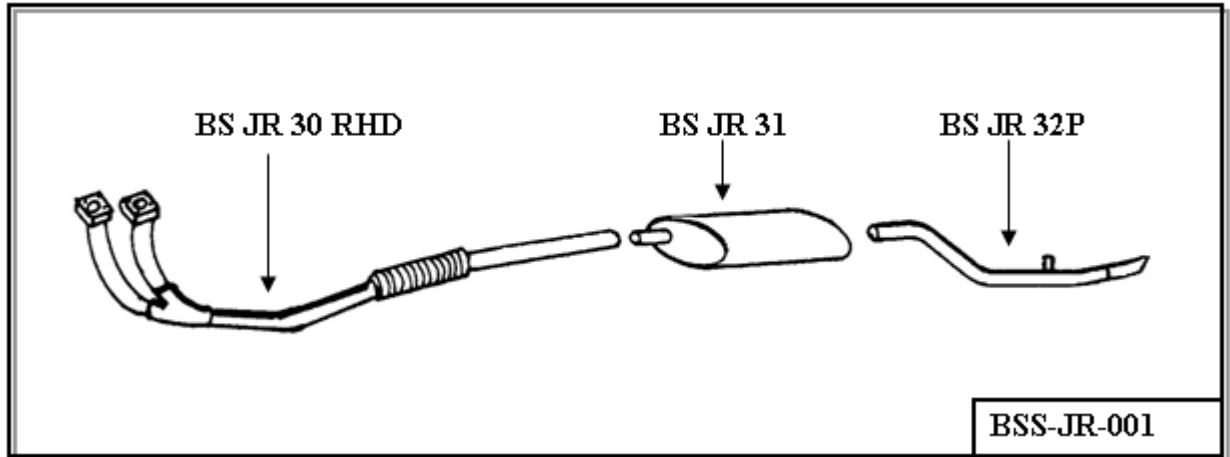

## XK 120/140 TWIN TAIL PIPE SPORT SYSTEM RHD ONLY

TWIN FRONT PIPE RHD ONLY  
SPECIAL SILENCER  
TAIL PIPE  
TAIL PIPE

BS JR 30RHD  
BS JR 41SP  
BS JR 36P  
BS JR 36P

**SYSTEM NUMBER**

**BSS-JR-002**

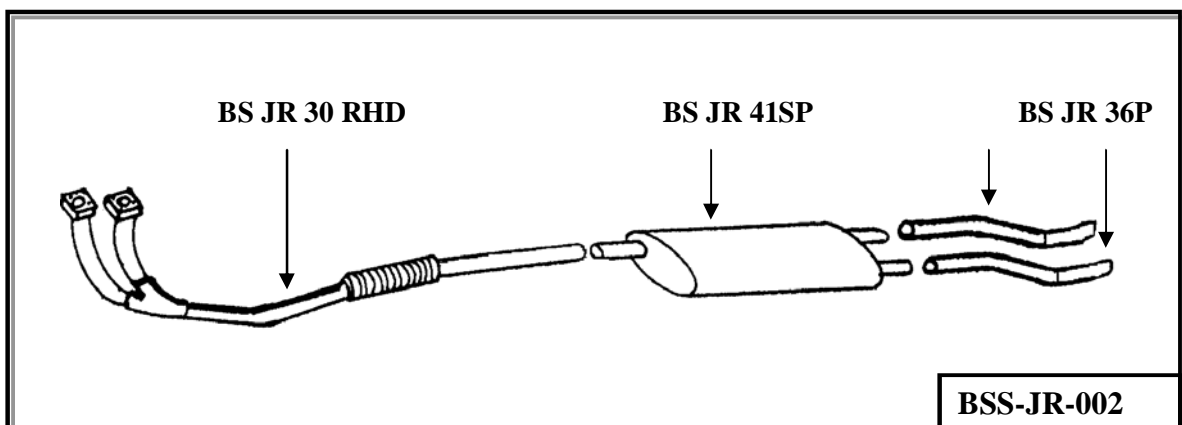

# JAGUAR

## **XK120/140 SINGLE SYSTEM LHD ONLY**

TWIN FRONT PIPE LHD ONLY  
SILENCER  
TAIL PIPE

BS JR 30LHD  
BS JR 31  
BS JR 32P

**SYSTEM NUMBER**

**BSS-JR-101**

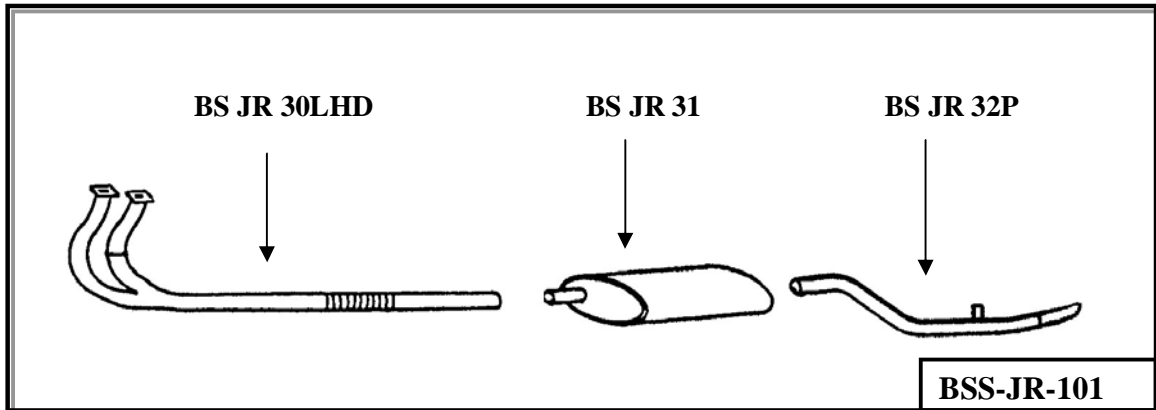

## **XK120/140 TWIN TAIL PIPE SPORT SYSTEM LHD ONLY**

TWIN FRONT PIPE LHD ONLY  
SPECIAL SILENCER  
TAIL PIPE  
TAIL PIPE

BS JR 30LHD  
BS JR 41SP  
BS JR 36P  
BS JR 36P

**SYSTEM NUMBER**

**BSS-JR-035**

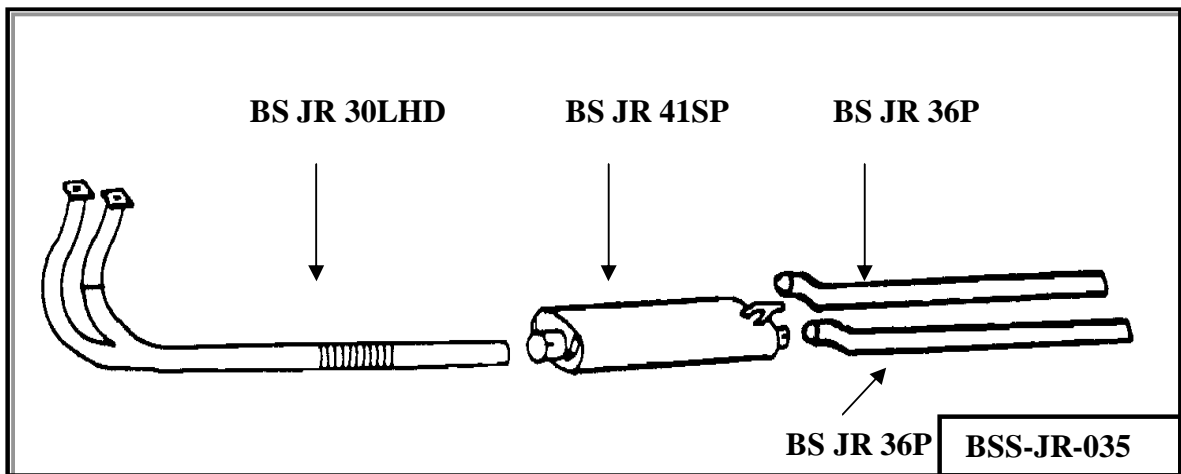

# JAGUAR

## XK 140/150 TWIN (1954-1960)

FRONT PIPE ASSEMBLY  
 FRONT PIPE ASSEMBLY  
 SILENCER  
 SILENCER  
 TAIL PIPE  
 TAIL PIPE

BS JR 37  
 BS JR 38  
 BS JR 39  
 BS JR 40  
 BS JR 43P  
 BS JR 44P

SYSTEM NUMBER

BSS-JR-003

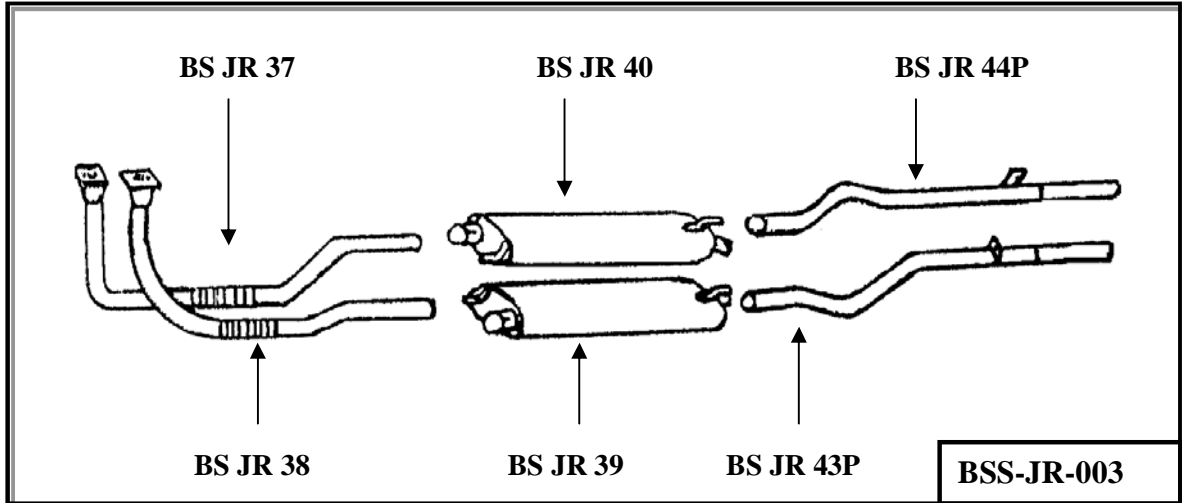

## XK 140/150 TWIN (1954-1960) SPORT

FRONT PIPE ASSEMBLY  
 FRONT PIPE ASSEMBLY  
 SILENCER  
 SILENCER  
 TAIL PIPE  
 TAIL PIPE

BS JR 37  
 BS JR 38  
 BS JR 39SP  
 BS JR 40SP  
 BS JR 43P  
 BS JR 44P

SYSTEM NUMBER

BSS-JR-003SP

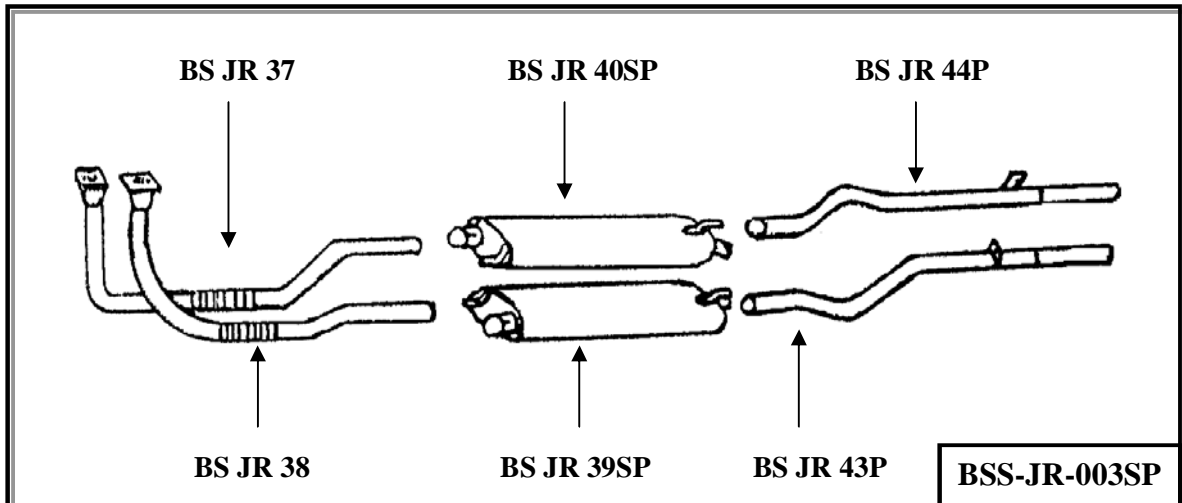

# JAGUAR

## XK140/150 TWIN (1954 – 1960) AUTOMATIC

FRONT PIPE ASSEMBLY	BS JR 38
FRONT PIPE ASSEMBLY AUTO ONLY	BS JR 42
SILENCER	BS JR 39
SILENCER	BS JR 40
TAIL PIPE	BS JR 43P
TAIL PIPE	BS JR 44P

**SYSTEM NUMBER** **BSS-JR-036**

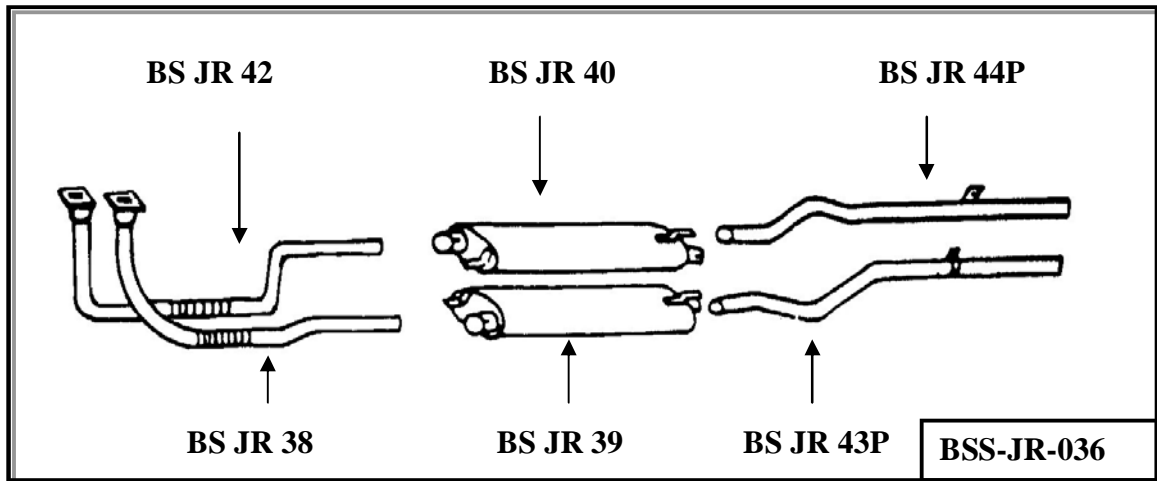

## JAGUAR 2.4 MK I (1955 – 1959)

TWIN FRONT PIPE	BS JR 18
JAGUAR MK I MIDDLE BOX	BS JR 19
JAGUAR MK I TAIL PIPE	BS JR 20P

**SYSTEM NUMBER** **BSS-JR-004**

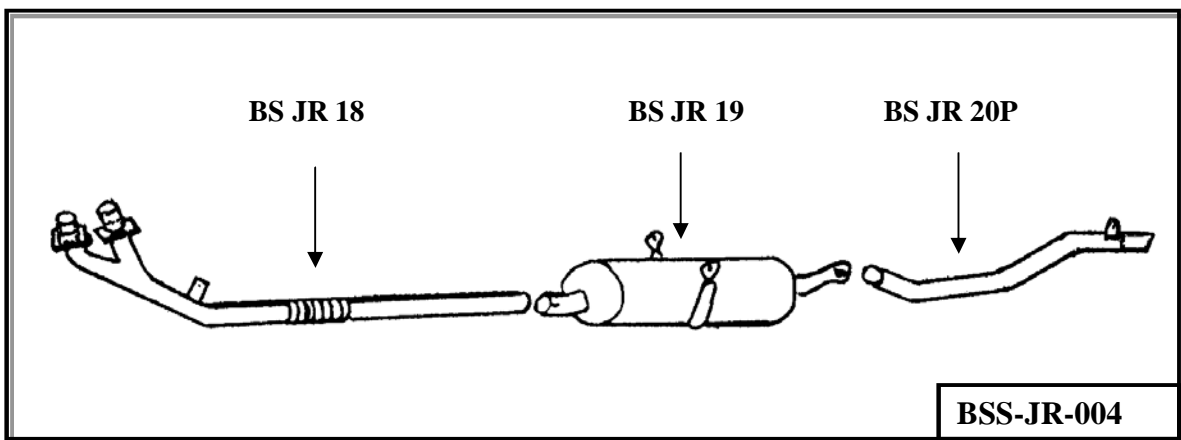

# JAGUAR

## 2.4 MKII SINGLE SYSTEM TO 1967

TWIN FRONT PIPE  
SILENCER AND SUPPORT  
TAIL PIPE  
CHROME TRIM

BS JR 69  
BS JR 115  
BS JR 114  
BS JR 112P

**SYSTEM NUMBER**

**BSS-JR-005**

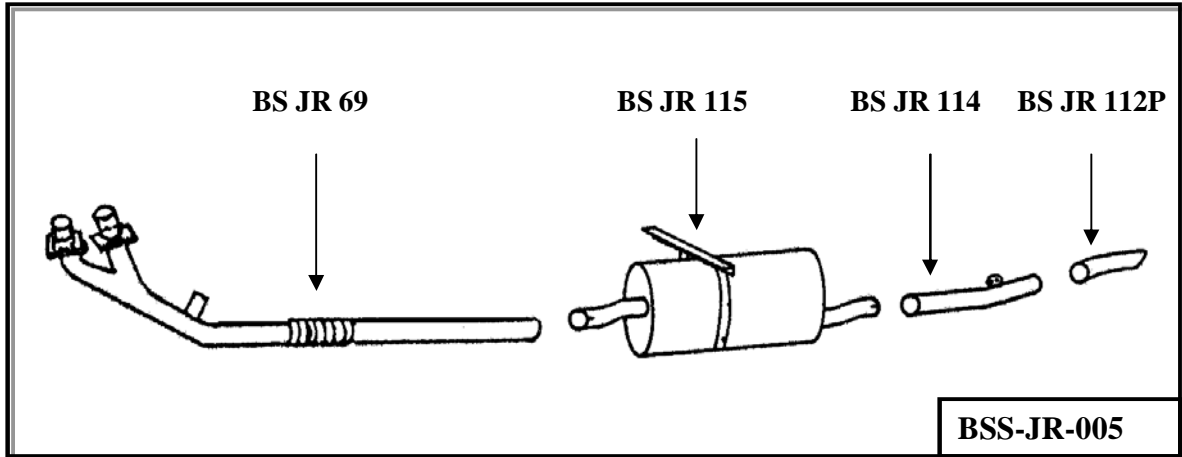

## 240 SALOON (1967 – 1969)

FRONT PIPE  
FRONT PIPE  
TWIN BOX ASSEMBLY  
TWIN TAIL PIPE ASSEMBLY

BS JR 118  
BS JR 119  
BS JR 110  
BS JR 35P

**SYSTEM NUMBER**

**BSS-JR-006**

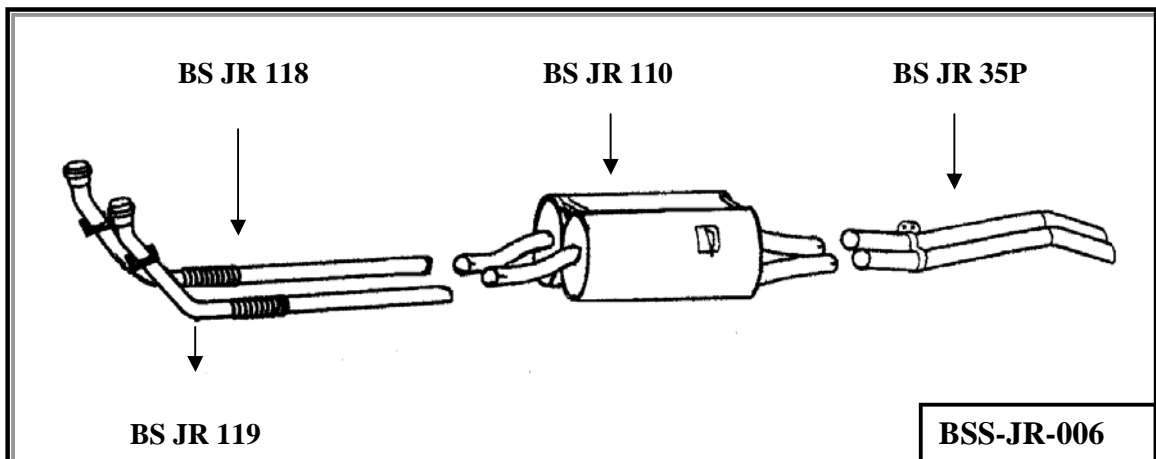

# JAGUAR

## 3.4 MKII 3.8MKII (1960 – 1961)

FRONT PIPE  
FRONT PIPE  
TWIN BOX ASSEMBLY  
TWIN TAIL PIPE ASSEMBLY

BS JR 59  
BS JR 60  
BS JR 110  
BS JR 35P

**SYSTEM NUMBER**

**BSS-JR-007**

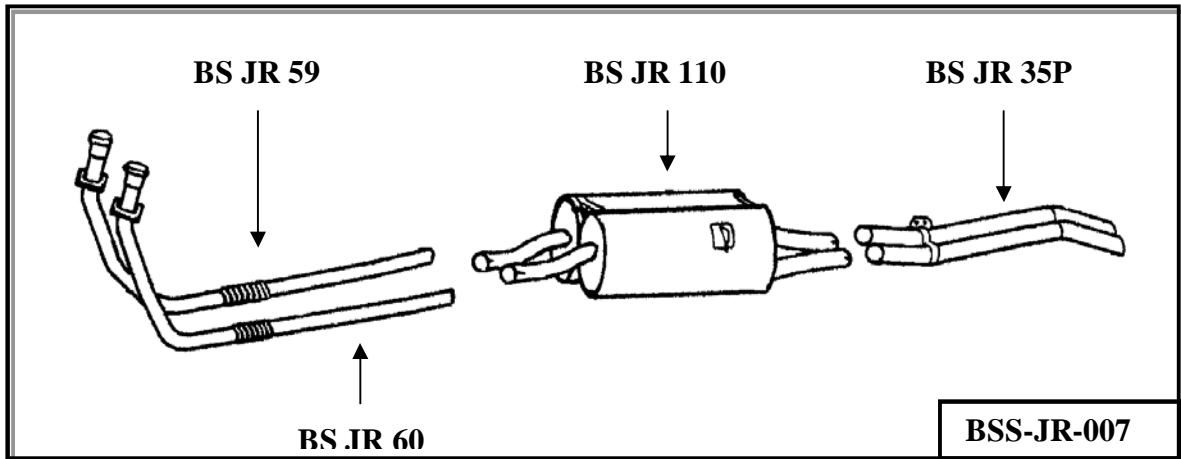

## 3.4 MKII (1961 – 1962) 3.8 MKII (1961 - 1963)

FRONT PIPE  
FRONT PIPE  
TWIN BOX ASSEMBLY  
TWIN TAIL PIPE ASSEMBLY

BS JR 70  
BS JR 71  
BS JR 110  
BS JR 35P

**SYSTEM NUMBER**

**BSS-JR-008**

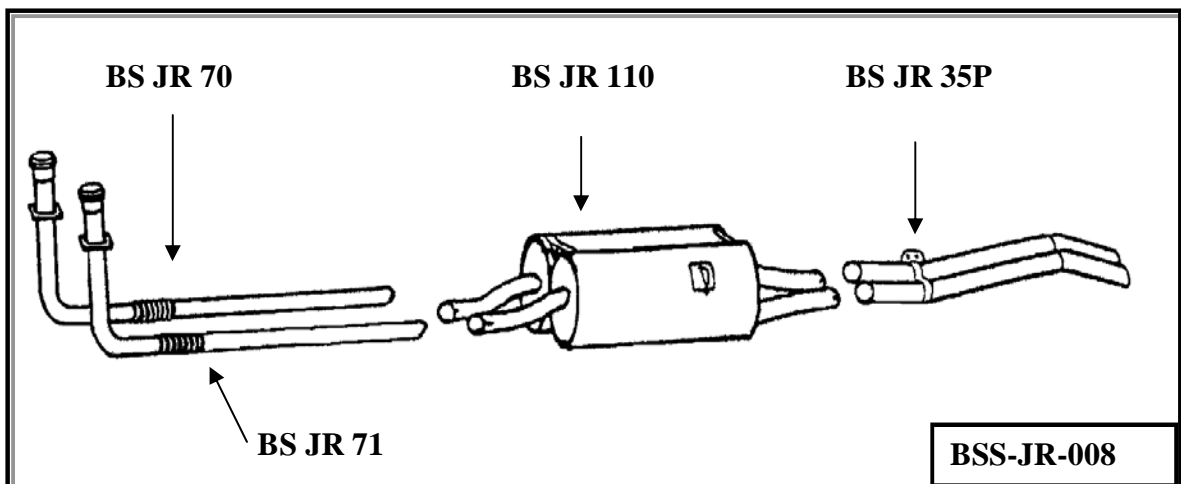

# JAGUAR

## 3.4 MKII (1962-1963) 3.8 MKII (1963-1964)

FRONT PIPE  
FRONT PIPE  
TWIN BOX ASSEMBLY  
TWIN TAIL PIPE ASSEMBLY

BS JR 70  
BS JR 71  
BS JR 110  
BS JR 35P

**SYSTEM NUMBER**

**BSS-JR-009**

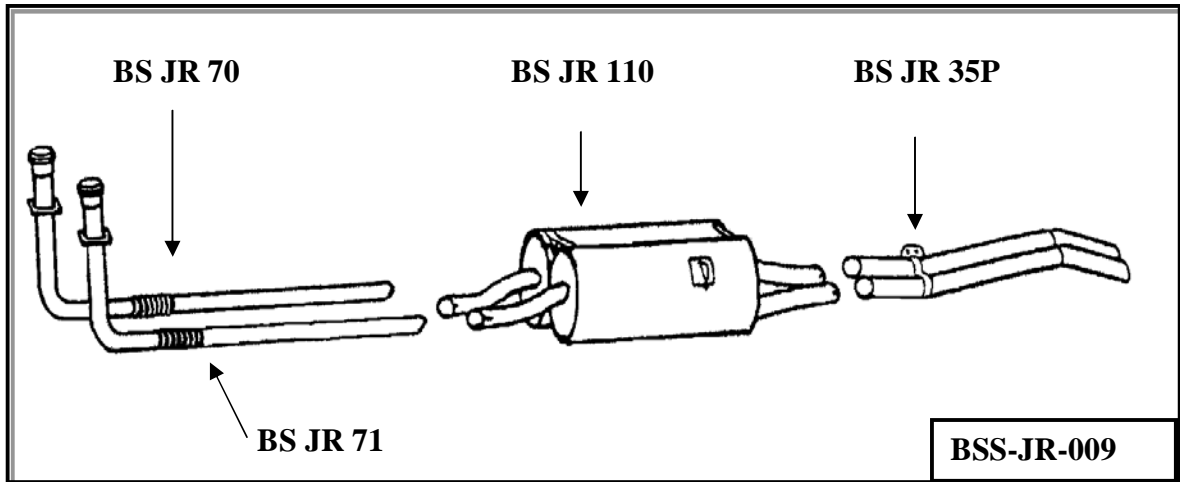

## 340 SALOON (1967 – 1969)

FRONT PIPE  
FRONT PIPE  
TWIN BOX ASSEMBLY  
TWIN TAIL PIPE ASSEMBLY

BS JR 70  
BS JR 71  
BS JR 110  
BS JR 35P

**SYSTEM NUMBER**

**BSS-JR-010**

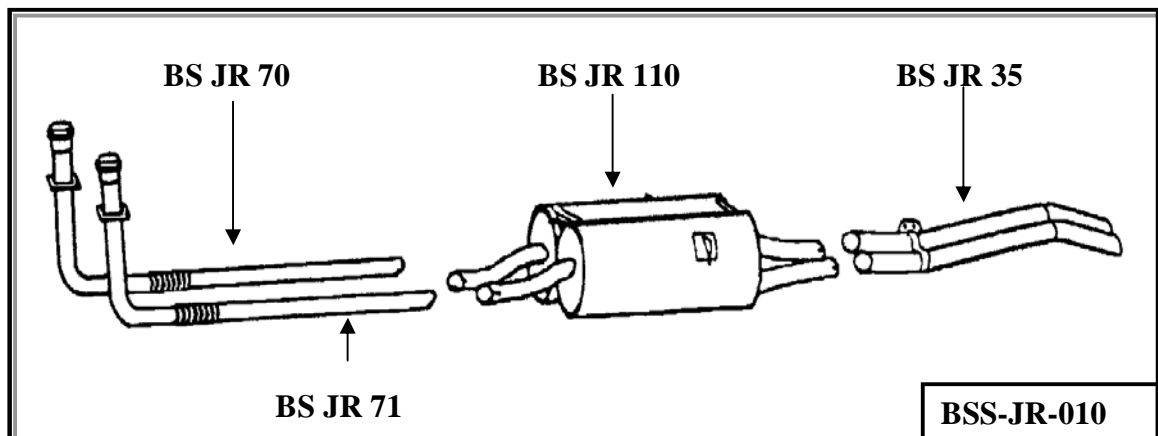



# JAGUAR

## S TYPE 3.4 420 SOVEREIGN (1963 – 1969)

FRONT PIPE RH	BS JR 61
FRONT PIPE LH	BS JR 62
SILENCER	BS JR 48
INTERPIPE RH	BS JR 63
INTERPIPE LH	BS JR 64
SILENCER RH	BS JR 65
SILENCER LH	BS JR 66
SILENCER & TAIL PIPE RH	BS JR 98
SILENCER & TAIL PIPE LH	BS JR 99
CHROME TRIM	BS JR 100P
CHROME TRIM	BS JR 100P

**SYSTEM NUMBER**

**BSS-JR-011**

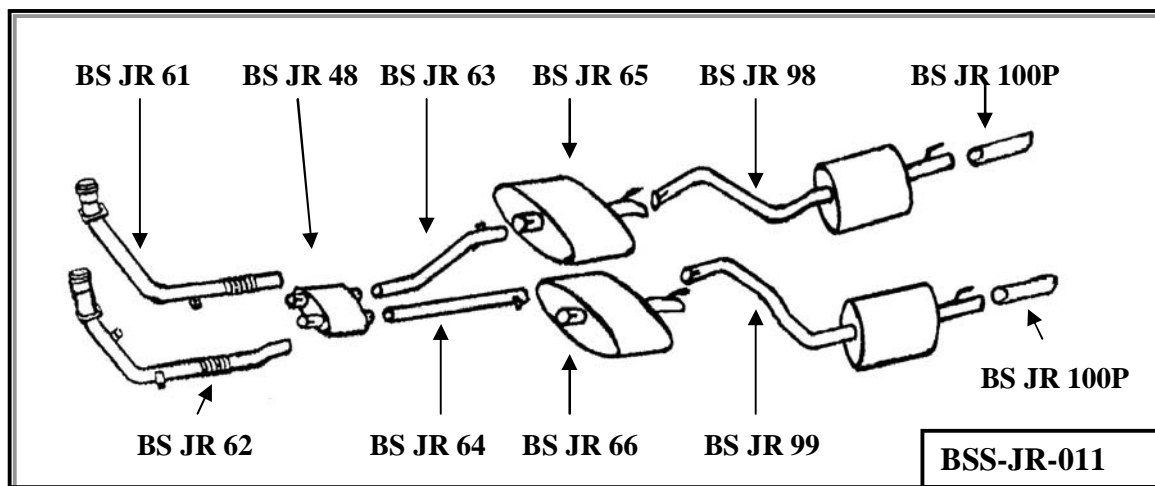

# JAGUAR

## DAIMLER 2.5 V8

FRONT PIPE LH

BS JR 72

FRONT PIPE LH

BS JR 73

BALANCE PIPE

BS JR 74

INTERPIPE

BS JR 82

INTERPIPE

BS JR 82

SILENCER & INTERPIPE

BS JR 92

SILENCER & INTERPIPE

BS JR 93

STRAIGHT TAIL TRIM XJ6

BS JR 94P

STRAIGHT TAIL TRIM XJ6

BS JR 94P

SYSTEM NUMBER

**BSS-JR-012**

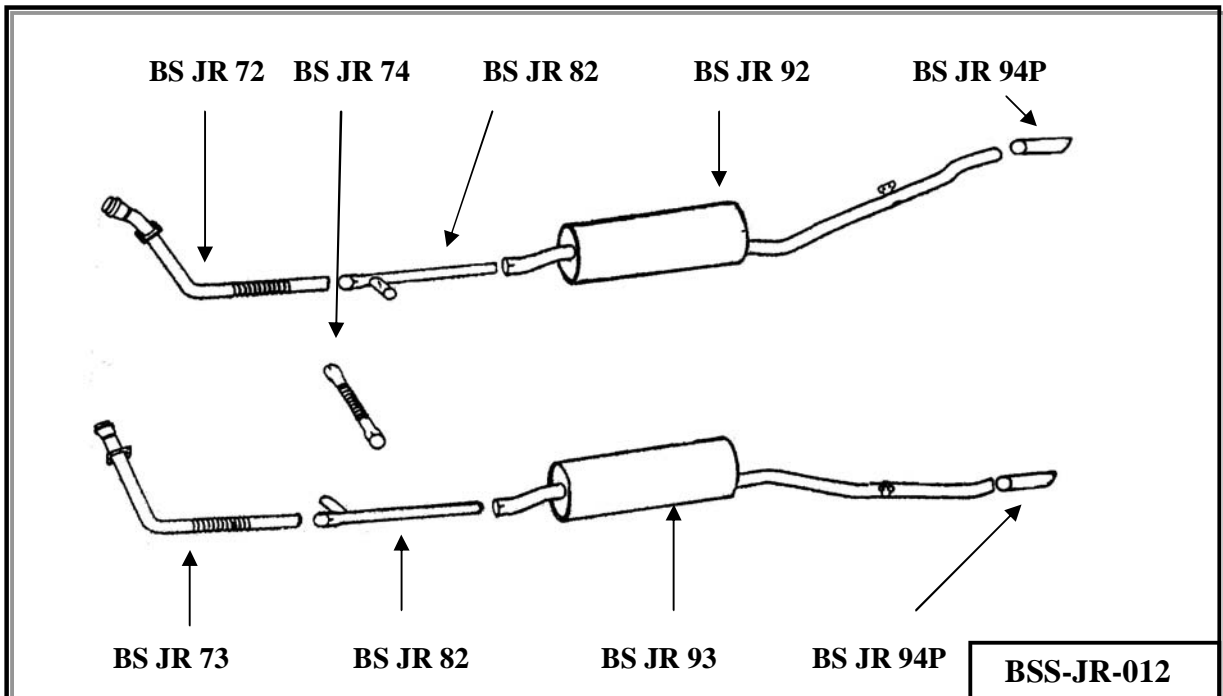

# JAGUAR

## DAIMLER DS 420 LIMOUSINE ALL YEARS

FRONT PIPE	BS JR 7
FRONT PIPE	BS JR 8
SILENCER	BS JR 48
LINK PIPE	BS JR 9
LINK PIPE	BS JR 6
SILENCER	BS JR 52
SILENCER	BS JR 52
SILENCER & TAIL PIPE ASSEMBLY	BS JR 88
SILENCER & TAIL PIPE ASSEMBLY	BS JR 89

SYSTEM NUMBER

BS-JR-013

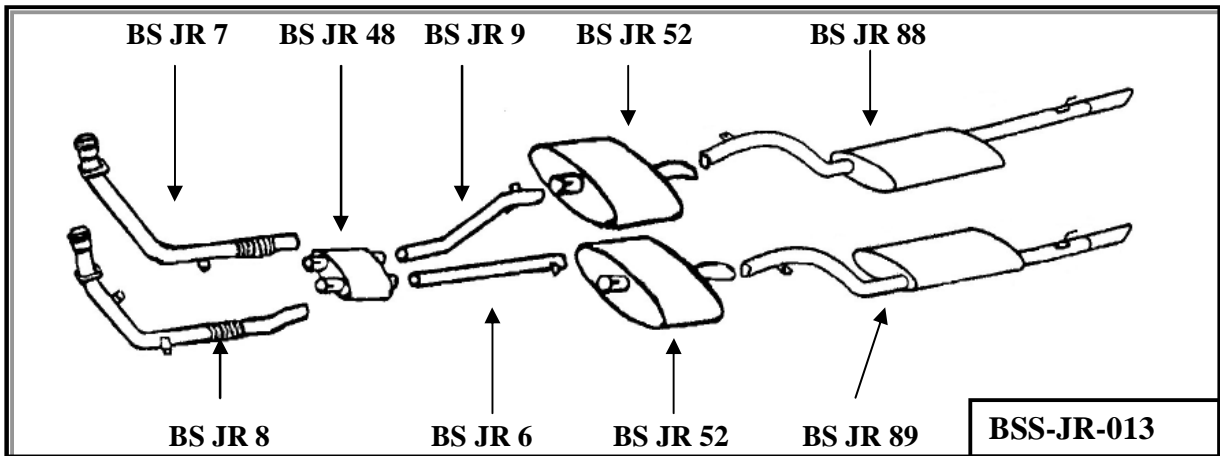

MK 10 3.8 4.2 420G (1961-1968)

FRONT PIPE FRONT	BS JR 46
FRONT PIPE REAR	BS JR 87
SILENCER	BS JR 48
INTERPIPE LH	BS JR 49
INTERPIPE	BS JR 50
SILENCER	BS JR 52
SILENCER	BS JR 52
SILENCER & TAIL PIPE ASSEMBLY	BS JR 88
SILENCER & TAIL PIPE ASSEMBLY	BS JR 89

SYSTEM NUMBER

BSS-JR-014

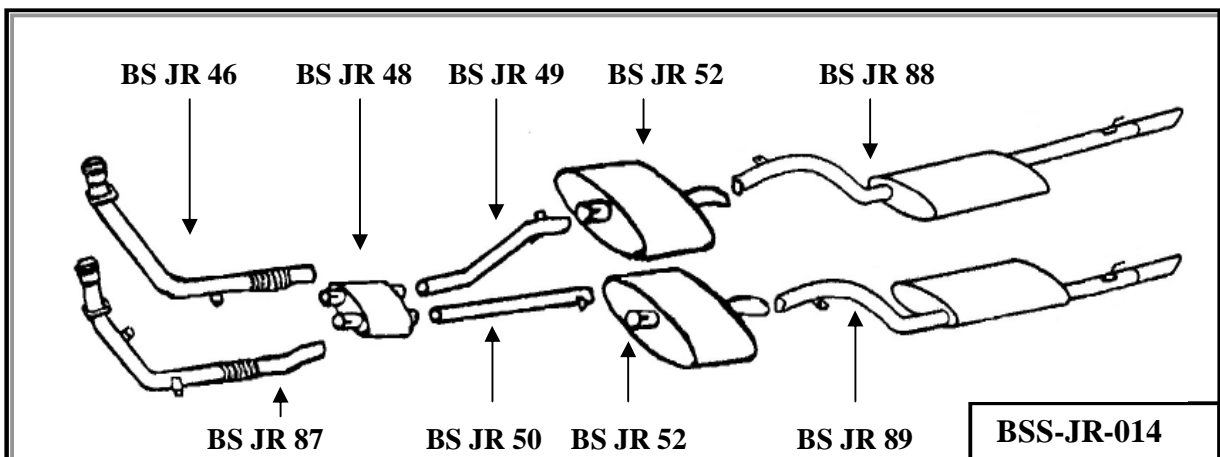

# JAGUAR

## E TYPE 6 CYL 3.8 SER 1 (1961-1968)

FRONT PIPE FRONT	BS JR 55
FRONT REAR	BS JR 56
TWIN SILENCER ASSEMBLY	BS JR 57
INTERPIPE RH	BS JR 83
INTERPIPE LH	BS JR 84
REAR BOX & TAIL PIPE RH	BS JR 23P
REAR BOX & TAIL PIPE LH	BS JR 24P

**SYSTEM NUMBER** **BSS-JR-015**

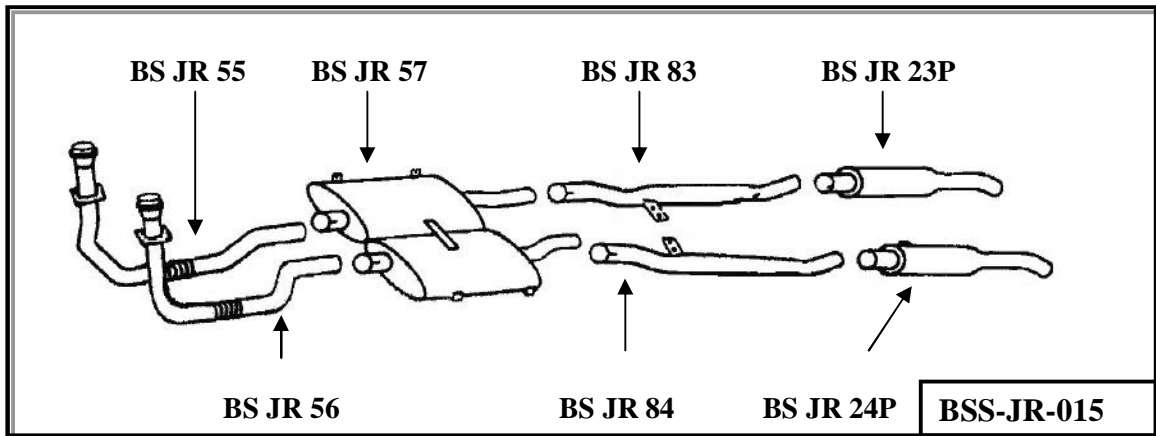

## E TYPE 6 CYL 4.2 SER.1 (1964-1968)

FRONT PIPE FRONT	BS JR 55
FRONT PIPE FRONT	BS JR 56
TWIN SILENCER ASSEMBLY	BS JR 57
INTERPIPE RH	BS JR 83
INTERPIPE LH	BS JR 84
SILENCER & TAIL PIPE ASSEMBLY RH	BS JR 85P
SILENCER & TAIL PIPE ASSEMBLY LH	BS JR 86P

**SYSTEM NUMBER** **BSS-JR-016**

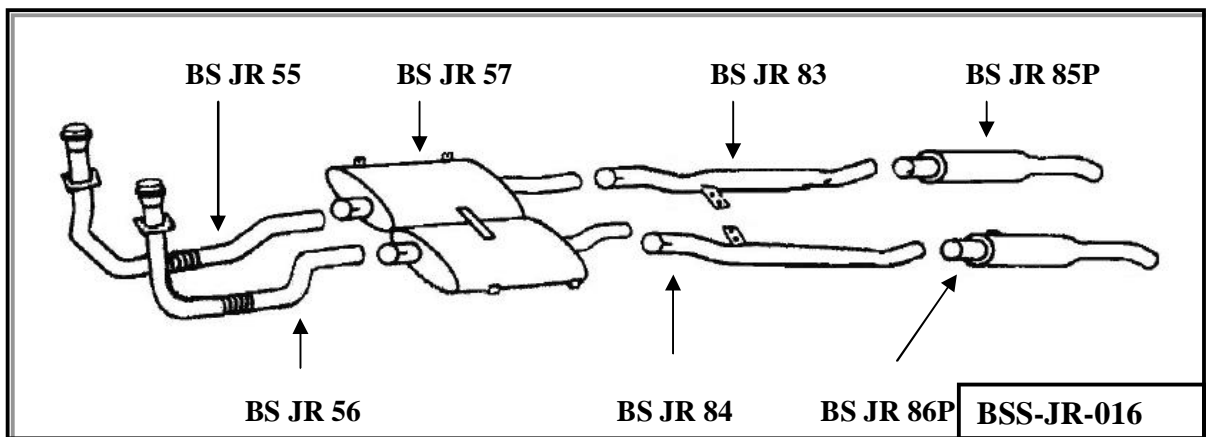

# JAGUAR

## E TYPE 6 CYL 4.2 SER.2 (1964-1968)

FRONT PIPE FRONT	BS JR 55
FRONT PIPE REAR	BS JR 56
TWIN SILENCER ASSY	BS JR 57
INTERPIPE RH	BS JR 83
INTERPIPE LH	BS JR 84
SILENCER & T/P ASSEMBLY RH	BS JR 129P
SILENCER & T/P ASSEMBLY LH	BS JR 130P

**SYSTEM NUMBER** **BSS-JR-017**

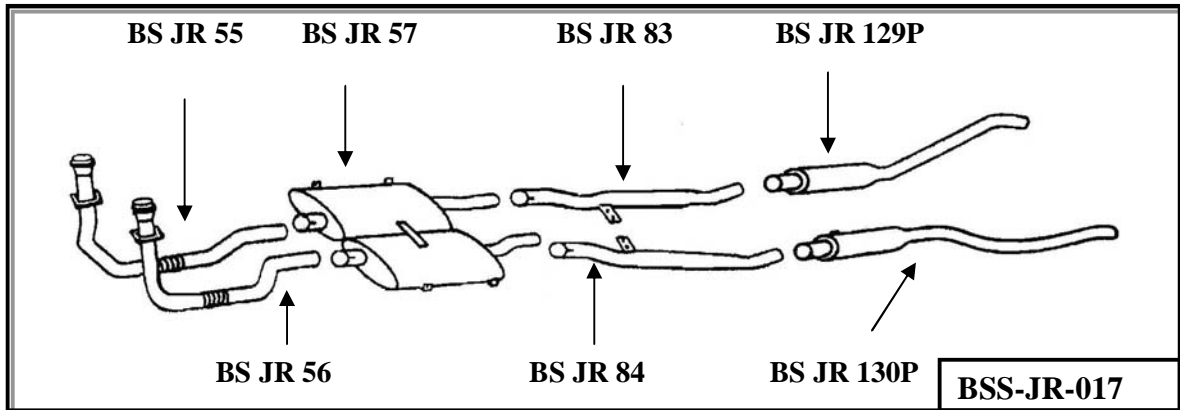

## E TYPE 6 CYL 2=2 SER. 1 (1966 - 1968)

TWIN FRONT PIPE	BS JR 116
FRONT SILENCER	BS JR 117
FRONT SILENCER	BS JR 117
INTERPIPE RH	BS JR 83
INTERPIPE LH	BS JR 84
SILENCER & T/P ASSEMBLY RH	BS JR 85P
SILENCER & T/P ASSEMBLY LH	BS JR 86P

**SYSTEM NUMBER** **BSS-JR-018**

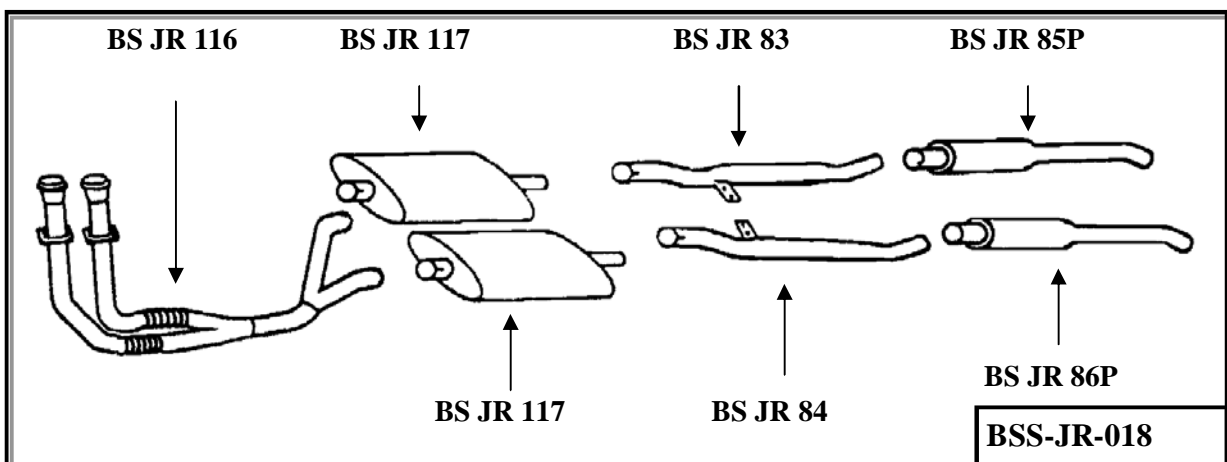

# JAGUAR

## E TYPE 6 CYL 4.2 SER.1 (1964 – 1968)

MANIFOLD	BS JR 532
MANIFOLD	BS JR 542
LINK PIPE WITH FLEX	BS JR 552
LINK PIPE WITH FLEX	BS JR 562
TWIN SILENCER ASSEMBLY BIG BORE	BS JR 572
INTERPIPE RH	BS JR 832
INTERPIPE LH	BS JR 842
SILENCER & T/P ASSY RH	BS JR 852
SILENCER & T/P ASSY LH	BS JR 862

**SYSTEM NUMBER**

**BSS-JR-116**

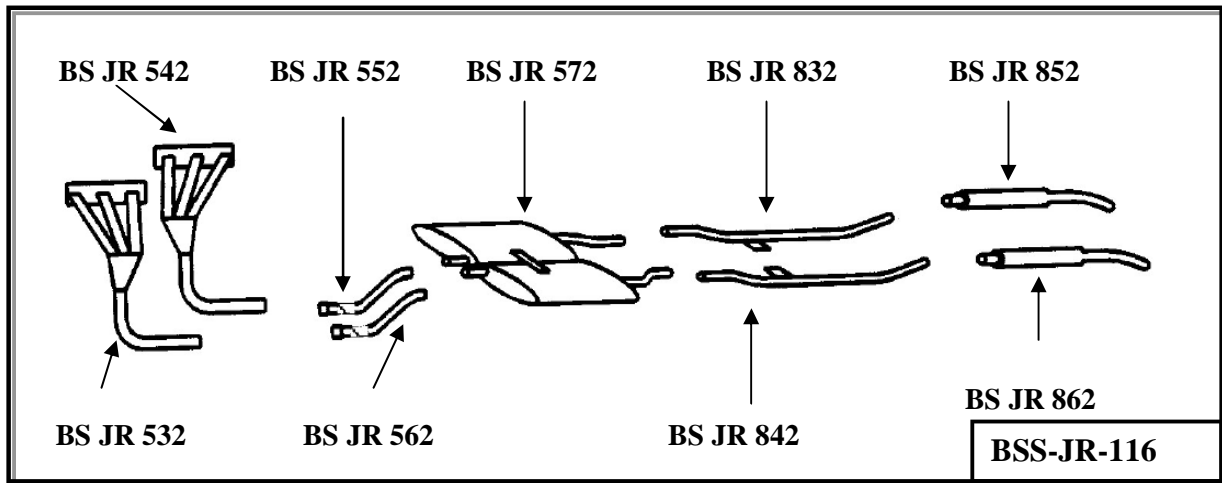

## TYPE 6 CYL 4.2 SER.1 (1964-1968)

FRONT PIPE FRONT BIG BORE	BS JR 55B
FRONT PIPE REAR BIG BORE	BS JR 56B
TWIN SILENCER ASSEMBLY BIG BORE	BS JR 572
INTERPIPE RH	BS JR 832
INTERPIPE LH	BS JR 842
SILENCER & T/P ASSEMBLY RH	BS JR 852
SILENCER & T/P ASSEMBLY LH	BS JR 862

**SYSTEM NUMBER**

**BSS-JR-216**

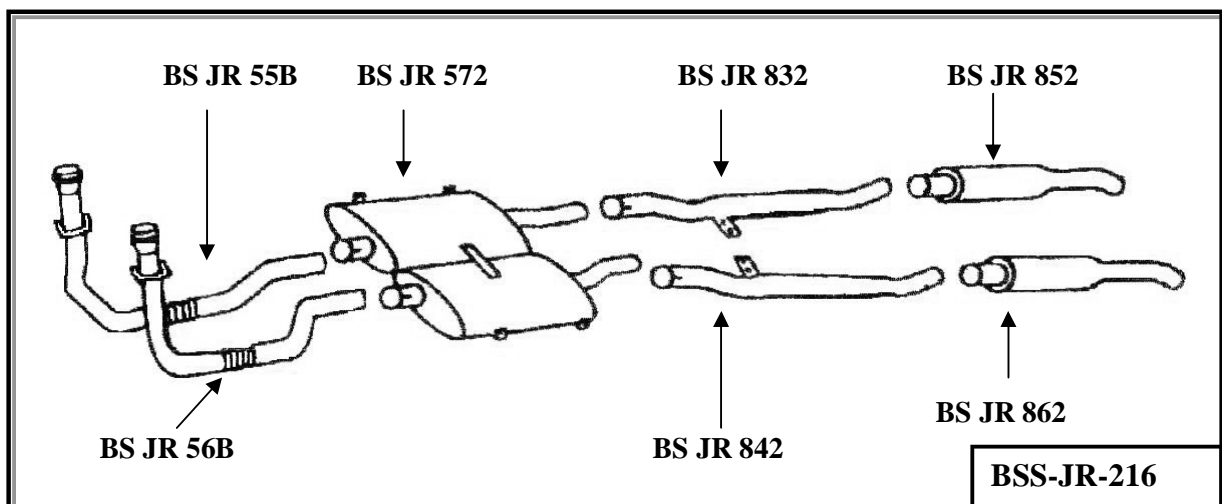

# JAGUAR

## E TYPE 6 CYL 2+2 SER.2 (1968-1971)

TWIN FRONT PIPE	BS JR 116
FRONT SILENCER	BS JR 117
FRONT SILENCER	BS JR 117
INTERPIPE RH	BS JR 83
INTERPIPE LH	BS JR 84
SILENCER & T/P ASSEMBLY RH	BS JR 129P
SILENCER & T/P ASSEMBLY LH	BS JR 130P
<b>SYSTEM NUMBER</b>	<b>BSS-JR-019</b>

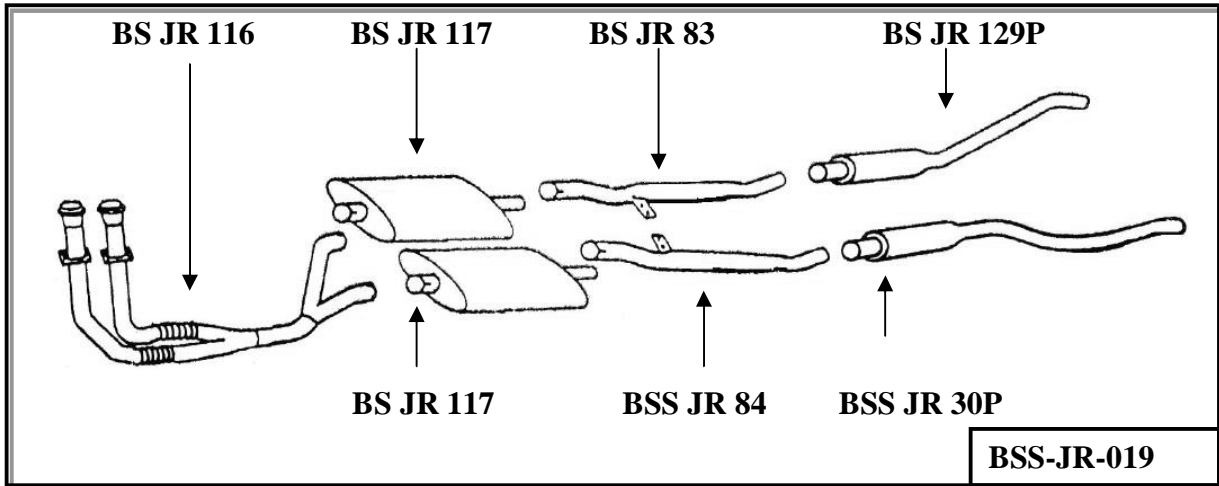

## E TYPE V12 QUAD OUTLET (1971-1974)

INTERPIPE RH	BS JR 140P
INTERPIPE LH	BS JR 141P
'H' PIPE	BS JR 163P
SILENCER	BS JR 142P
SILENCER	BS JR 142P
REAR SILENCER	BS JR 143P
<b>SYSTEM NUMBER</b>	<b>BSS-JR-020</b>

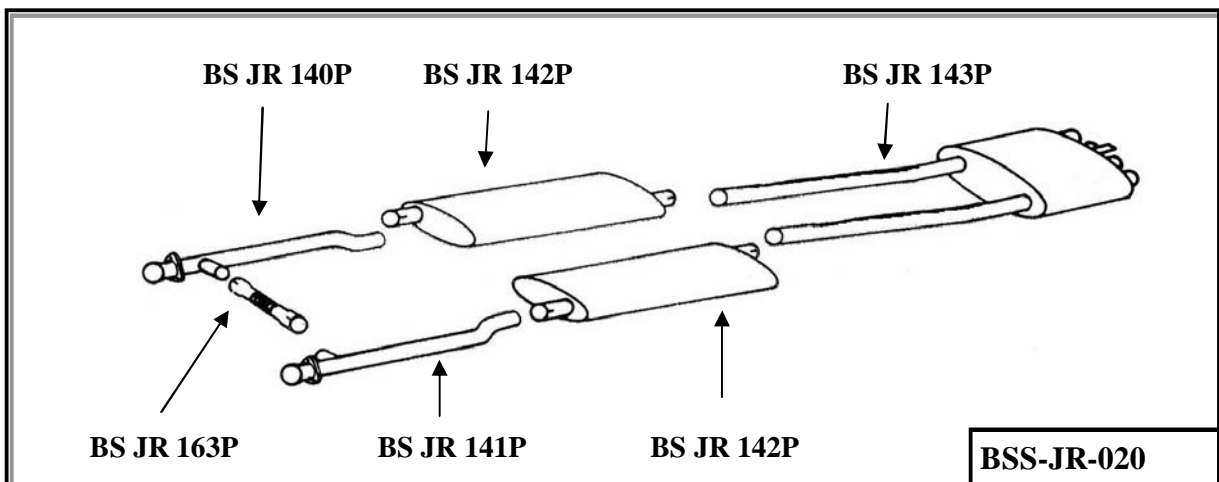

# JAGUAR

## E TYPE V12 TWIN OUTLET NO TRIM 71 ON

INTERPIPE RH

BS JR 140P

INTERPIPE LH

BS JR 141P

'H' PIPE

BS JR 163P

SILENCER

BS JR 142P

SILENCER

BS JR 142P

REAR SILENCER

BS JR 144P

SYSTEM NUMBER

BSS-JR-021

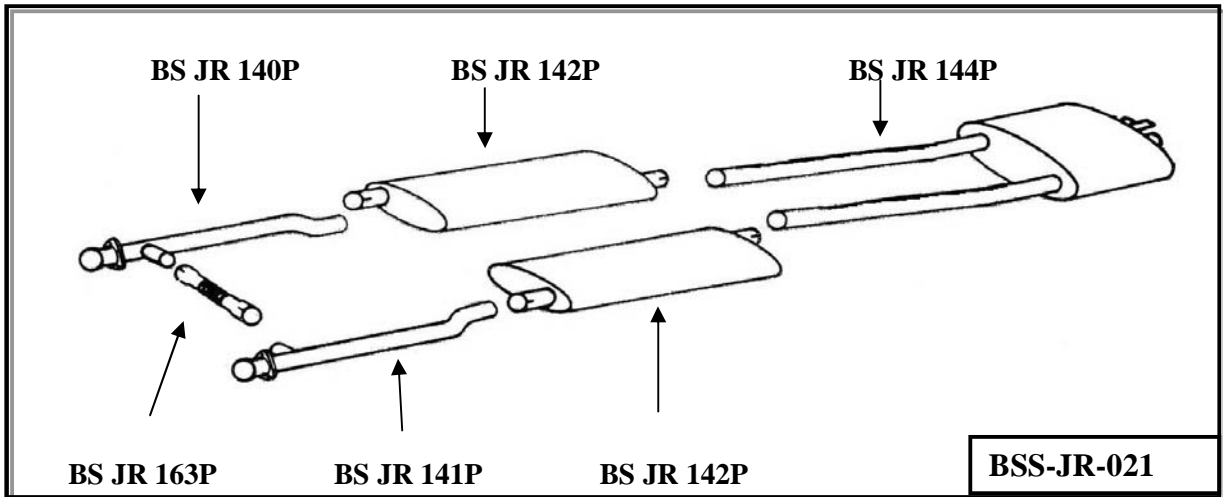

## E TYPE JAGUAR V12

R/HAND FRONT PIPE V 12 E TYPE

BS JR 138P

L/HAND FRONT PIPE V 12 E TYPE

BS JR 139P

INTERPIPE RH

BS JR 140P

INTERPIPE LH

BS JR 141P

'H' PIPE

BS JR 163P

SILENCER

BS JR 142

SILENCER

BS JR 142

REAR SILENCER

BS JR 143P

SYSTEM NUMBER

BSS-JR-031

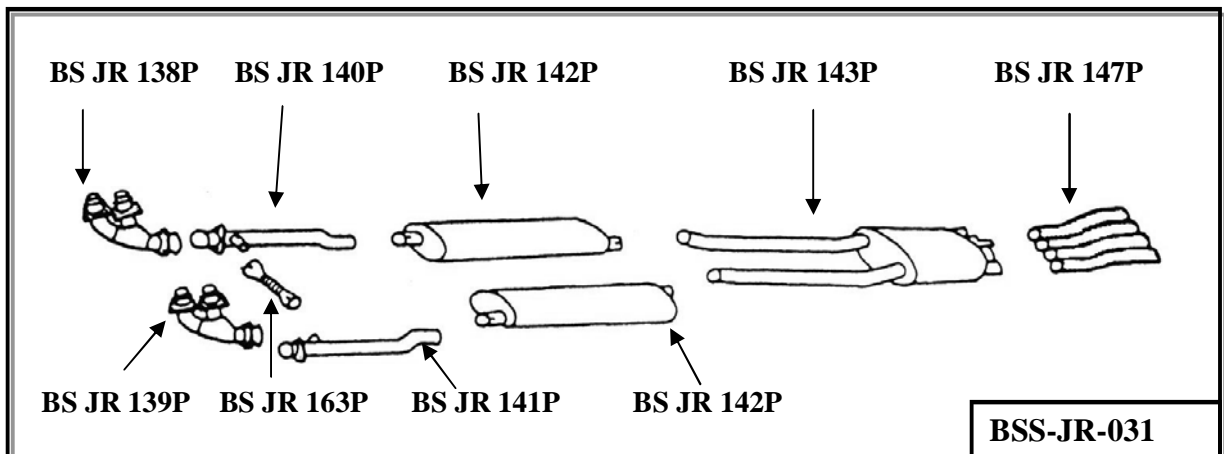



# JAGUAR

**XJ6 2.8 SER. 1 (1968 – 1973)**

FRONT PIPE ASSEMBLY

INTERPIPE RH

INTERPIPE LH

SILENCER RH

SILENCER LH

INTERPIPE RH

INTERPIPE LH

SILENCER RH

SILENCER LH

TAIL PIPE

TAIL PIPE

BS JR 133

BS JR 121

BS JR 132

BS JR 122

BS JR 123

BS JR 145

BS JR 146

BS JR 187

BS JR 188

BS JR 94P/BB

BS JR 94P/BB

**SYSTEM NUMBER**

**BSS-JR-022**

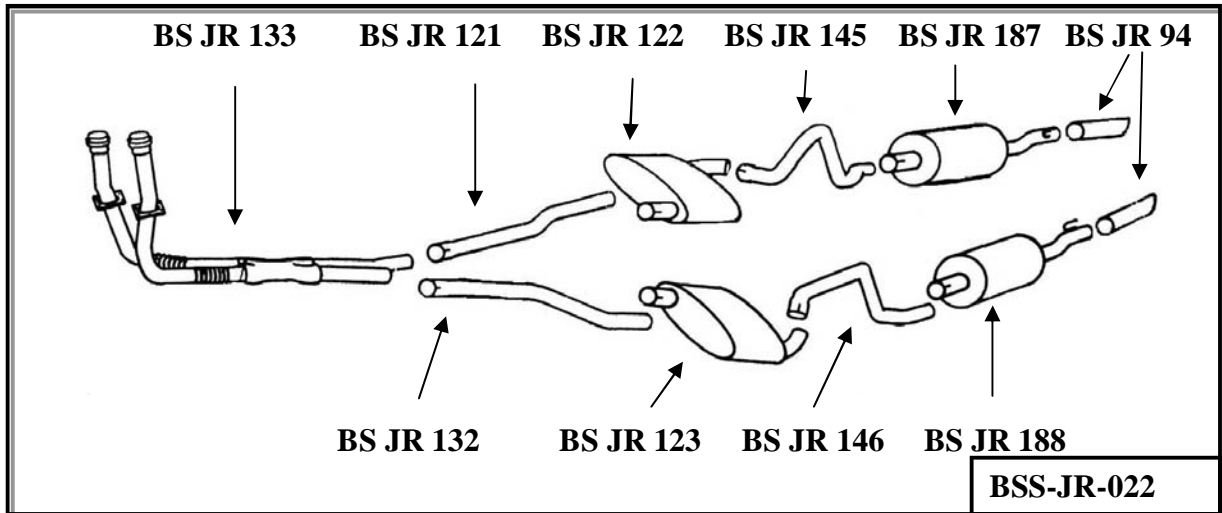

# JAGUAR

## XJ6 4.2 SER. 1 (1968 – 1973)

### FRONT PIPE ASSEMBLY

INTERPIPE LH

INTERPIPE RH

SILENCER RH

SILENCER LH

INTERPIPE RH

INTERPIPE LH

SILENCER RH

SILENCER LH

TAIL PIPE

TAIL PIPE

BS JR 131

BS JR 132

BS JR 121

BS JR 122

BS JR 123

BS JR 145

BS JR 146

BS JR 187

BS JR 188

BS JR 259

BS JR 260

### SYSTEM NUMBER

**BSS-JR-023**

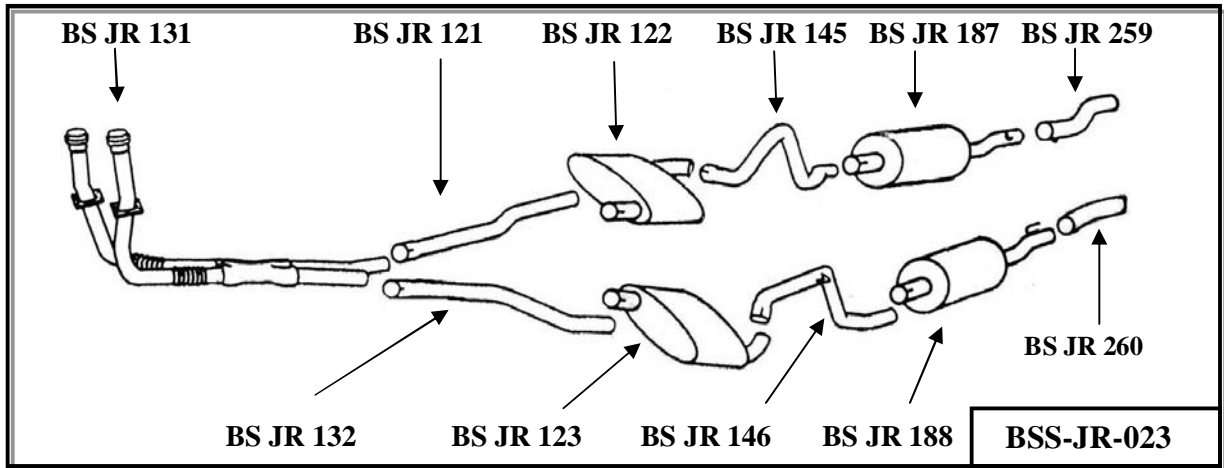

# JAGUAR

## XJ6 COUPE 76 – SLIDE JOINT SYSTEM

Y PIPE	BS JR 168
SILENCER RH	BS JR 122
SILENCER LH	BS JR 123
INTERPIPE RH	BS JR 145
INTERPIPE LH	BS JR 146
SILENCER RH	BS JR 187
SILNCER LH	BS JR 188
TAIL PIPE	BS JR 259
TAIL PIPE	BS JR 260

**SYSTEM NUMBER**

**BSS-JR-024**

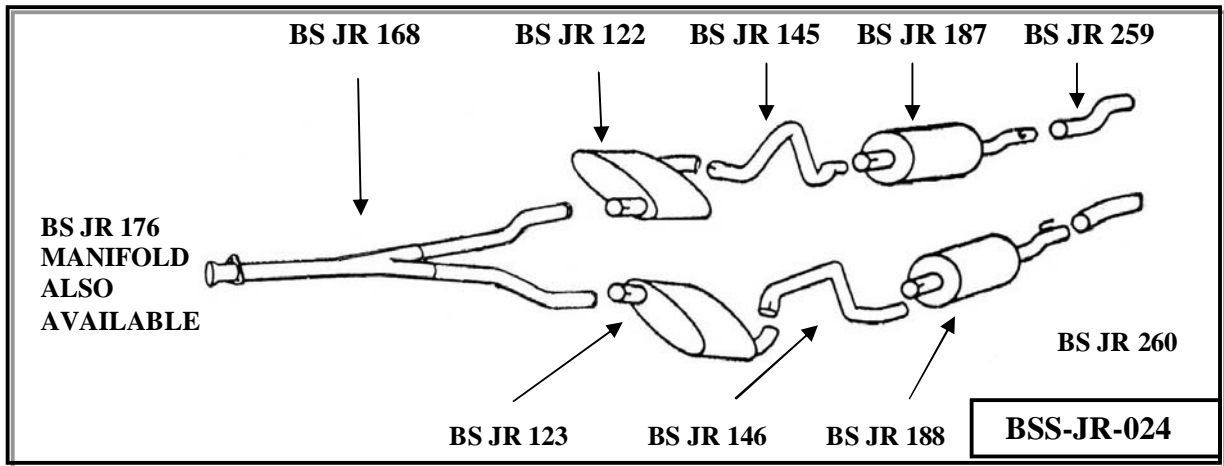

# JAGUAR

## XJ6 COUPE 76 – FLANGE JOINT SYSTEM

Y PIPE	BS JR 168
SILENCER RH	BS JR 204
SILENCER LH	BS JR 205
INTERPIPE RH	BS JR 202
INTERPIPE LH	BS JR 203
SILENCER RH	BS JR 187
SILENCER LH	BS JR 188
TAIL PIPE	BS JR 259
TAIL PIPE	BS JR 260

**SYSTEM NUMBER**

**BSS-JR-025**

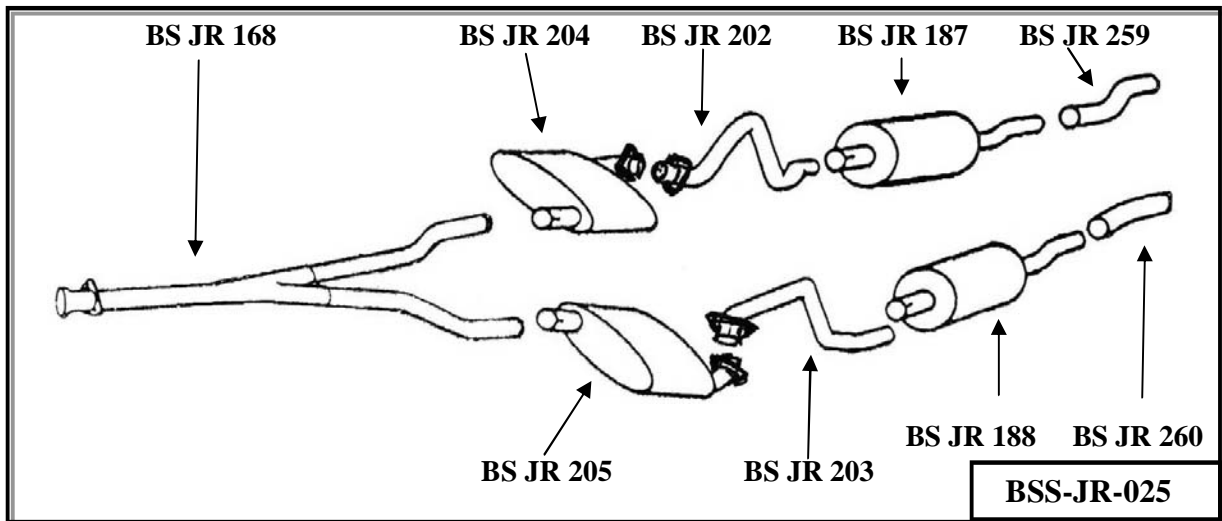

# JAGUAR

## XJ6 SALOON 74-76 SIDE JOINT SYSTEM

'Y' PIPE	BS JR 169
SILENCER RH	BS JR 122
SILENCER LH	BS JR 123
INTERPIPE RH	BS JR 145
INTERPIPE LH	BS JR 146
SILENCER RH	BS JR 187
SILENCER LH	BS JR 188
TAIL PIPE	BS JR 259
TAIL PIPE	BS JR 260

**SYSTEM NUMBER**

**BSS-JR-026**

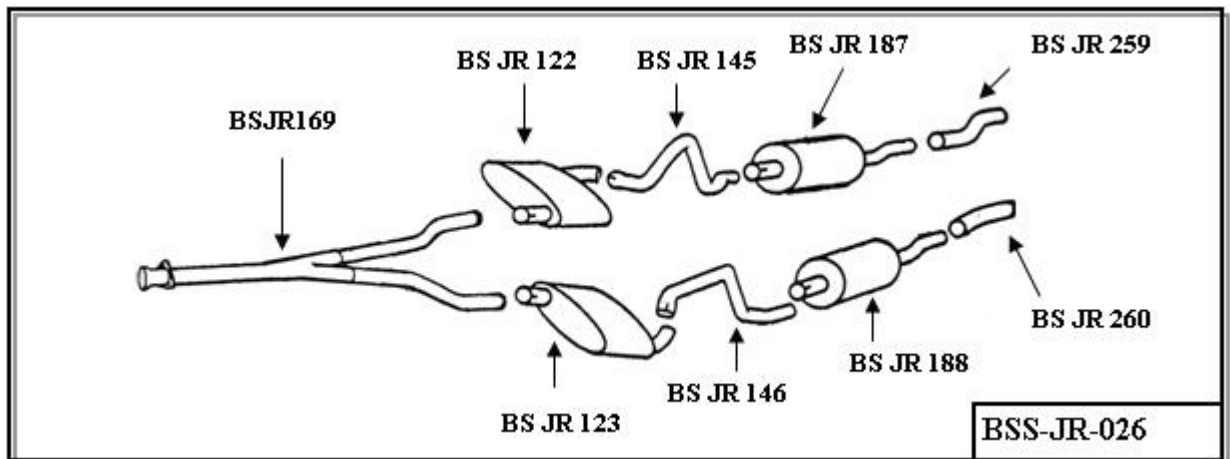

MANIFOLD IS ALSO AVAILABLE FOR THIS SYSTEM AS AN ADDED EXTRA IF REQUIRED

**PART NUMBER**

**BS JR 176**

# JAGUAR

## XJ6 SALOON SER.2/3 FLANGE JOINT - 1981

'Y' PIPE	BS JR 169
SILENCER RH	BS JR 204
SILENCER LH	BS JR 205
INTERPIPE RH	BS JR 202
INTERPIPE LH	BS JR 203
SILENCER RH	BS JR 187
SILENCER LH	BS JR 188
TAIL PIPE	BS JR 259
TAIL PIPE	BS JR 260

**SYSTEM NUMBER**

**BSS-JR-027**

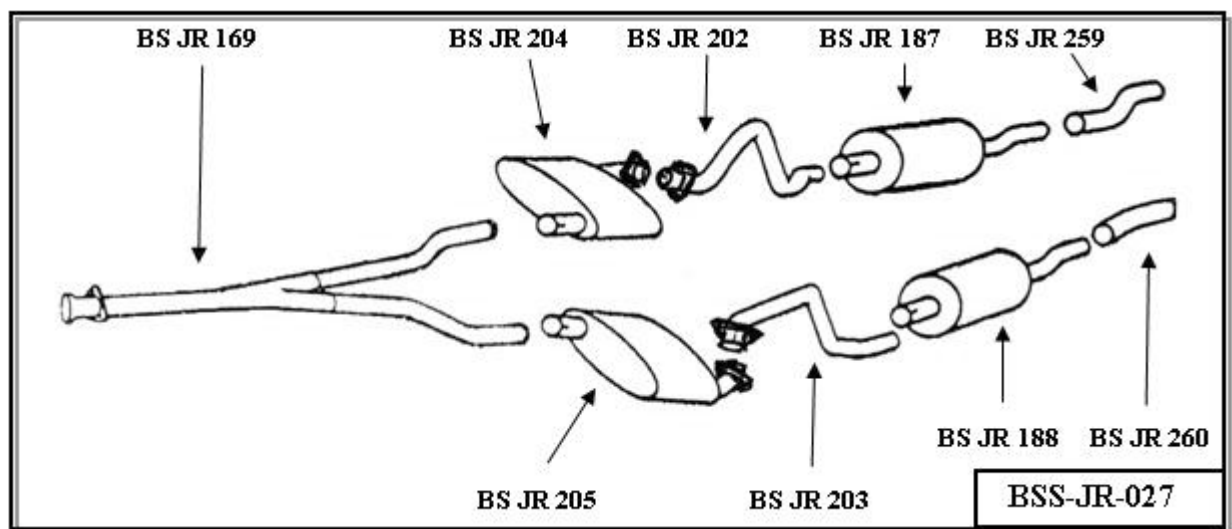

MANIFOLD IS ALSO AVAILABLE FOR THIS SYSTEM AS AN ADDED EXTRA IF REQUIRED

**PART NUMBER**

**BS JR 176**

# JAGUAR

## XJ6 SALOON SER.3 (1981-1987)

'Y' PIPE	BS JR 169
SILENCER RH	BS JR 204
SILENCER LH	BS JR 205
AXLE PIPE RH XJ6 81	BS JR 222
AXLE PIPE LH XJ6 81	BS JR 223
SILENCER RH	BS JR 187
SILENCER LH	BS JR 188
TAIL PIPE	BS JR 259
TAIL PIPE	BS JR 260

**SYSTEM NUMBER**

**BSS-JR-028**

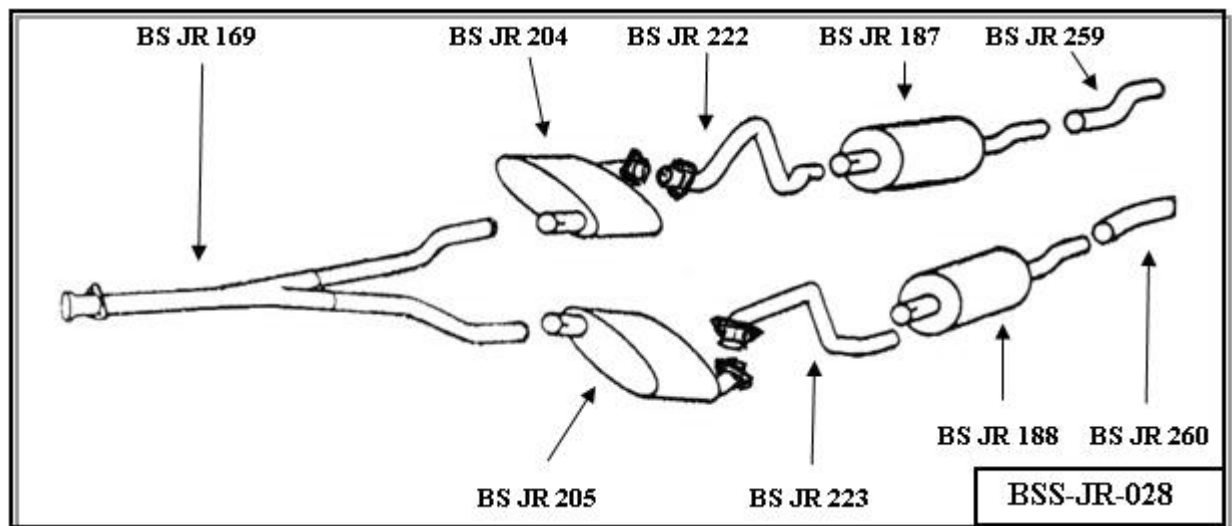

MANIFOLD IS ALSO AVAILABLE TO THIS SYSTEM AS AN ADDED EXTRA IF REQUIRED

**PART NUMBER**

**BS JR 220**

# JAGUAR

**XJS HE SER. 2&3 1976-**

F/INTERPIPES	BS JR 267
F/INTERPIPES	BS JR 267
SILENCER RH	BS JR 236
SILENCER LH	BS JR 237
AXLE PIPE RH	BS JR 263
AXLE PIPE LH	BS JR 264
SILENCER	BS JR 195
SILENCER	BS JR 195
TAIL PIPE	BS JR 196P
TAIL PIPE	BS JR 197P

**SYSTEM NUMBER** **BSS-JR-029**

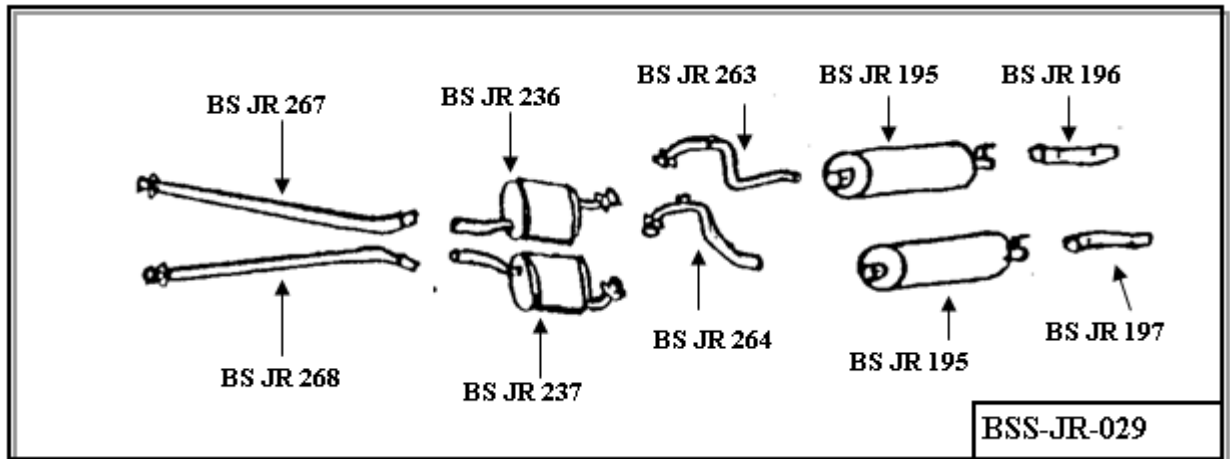

MANIFOLD PIPES ARE AVAILABLE FOR THIS SYSEM AS AN ADDED EXTRA IF REQUIRED

<b>PART NUMBER</b>	<b>BS JR 234P</b>
<b>PART NUMBER</b>	<b>BS JR 235P</b>





**STAINLESS STEEL EXHAUSTS**

West-Classic Tel: 0041 213 14 13 e-mail [west-classic@hotmail.com](mailto:west-classic@hotmail.com) Web: [www.west-classic.ch](http://www.west-classic.ch) / [www.west-motoren.ch](http://www.west-motoren.ch)

**MG**

**MG TC 1945 ON**

FRONT PIPE  
SILENCER  
TAIL PIPE

BS MG 394  
BS MG 395  
BS MG 396

**SYSTEM NUMBER**

**BSS-MG-001**

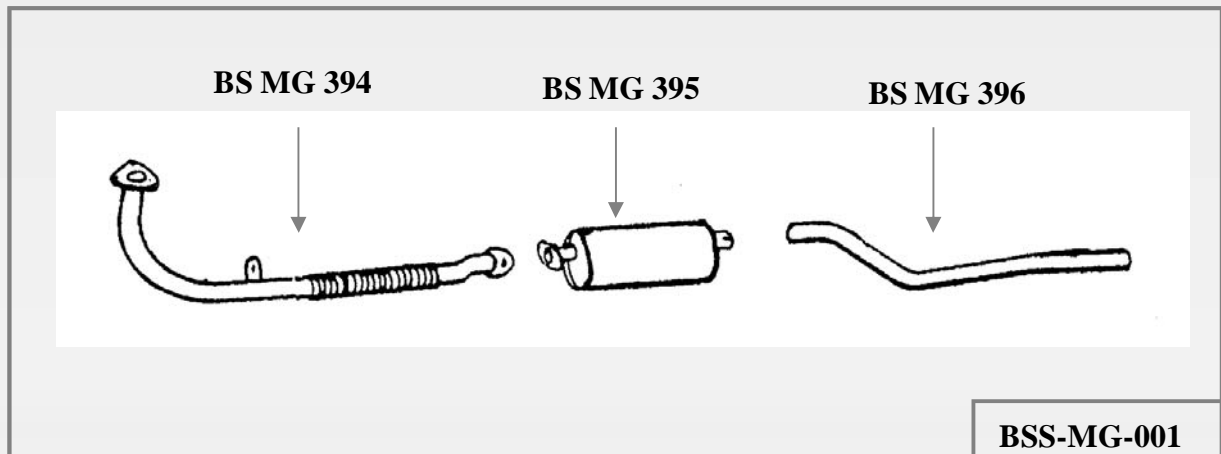



**STAINLESS STEEL EXHAUSTS**

West-Classic Tel: 0041 213 14 13 e-mail [west-classic@hotmail.com](mailto:west-classic@hotmail.com) Web: [www.west-classic.ch](http://www.west-classic.ch) / [www.west-motoren.ch](http://www.west-motoren.ch)

**MG**

**MG TC BIG BORE SYSTEM**

FRONT PIPE  
SILENCER  
TAIL PIPE

BS MG 394  
BS MG 395BB  
BS MG 396BB

**SYSTEM NUMBER**

**BSS-MG-101**

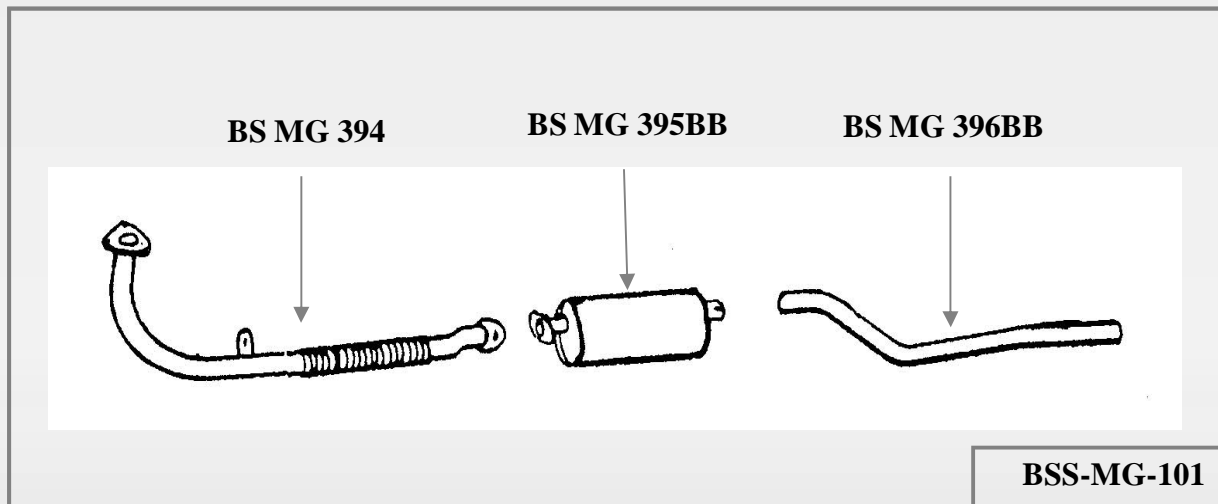



**STAINLESS STEEL EXHAUSTS**

West-Classic Tel: 0041 213 14 13 e-mail [west-classic@hotmail.com](mailto:west-classic@hotmail.com) Web: [www.west-classic.ch](http://www.west-classic.ch) / [www.west-motoren.ch](http://www.west-motoren.ch)

**MG**

**MG TD 1950 - 56**

FRONT PIPE  
SILENCER  
TAIL PIPE

BS MG 397  
BS MG 398  
BS MG 399

**SYSTEM NUMBER**

**BSS-MG-002**

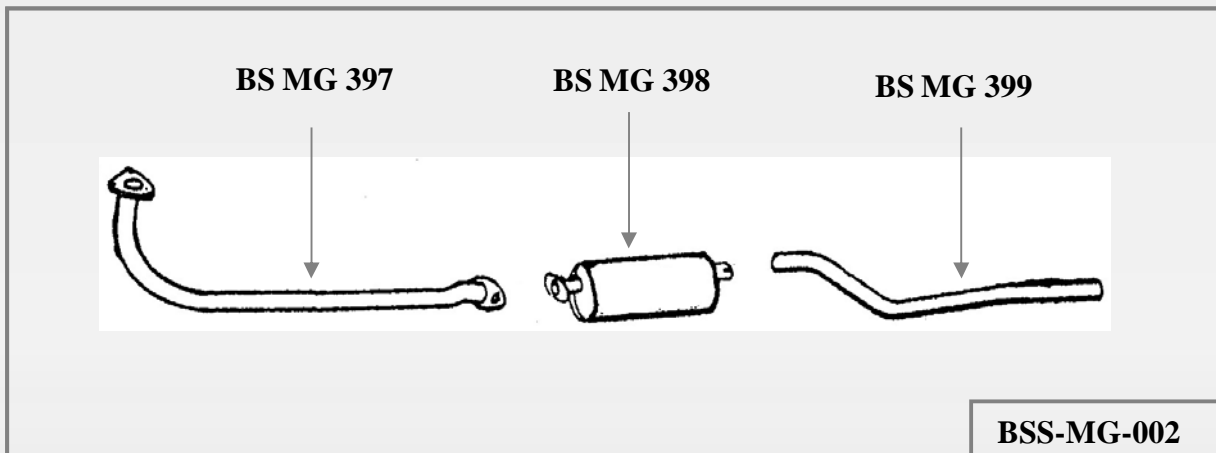



**STAINLESS STEEL EXHAUSTS**

West-Classic Tel: 0041 213 14 13 e-mail [west-classic@hotmail.com](mailto:west-classic@hotmail.com) Web: [www.west-classic.ch](http://www.west-classic.ch) / [www.west-motoren.ch](http://www.west-motoren.ch)

**MG**

**MG TF 1950 - 56**

FRONT PIPE MG TD/TF SLIP JOINT  
SILENCER TD/TF SLIP JOINT  
TAIL PIPE MG TD/TF SLIP JOINT

BS MG 400  
BS MG 401  
BS MG 402

**SYSTEM NUMBER**

**BSS-MG-003**

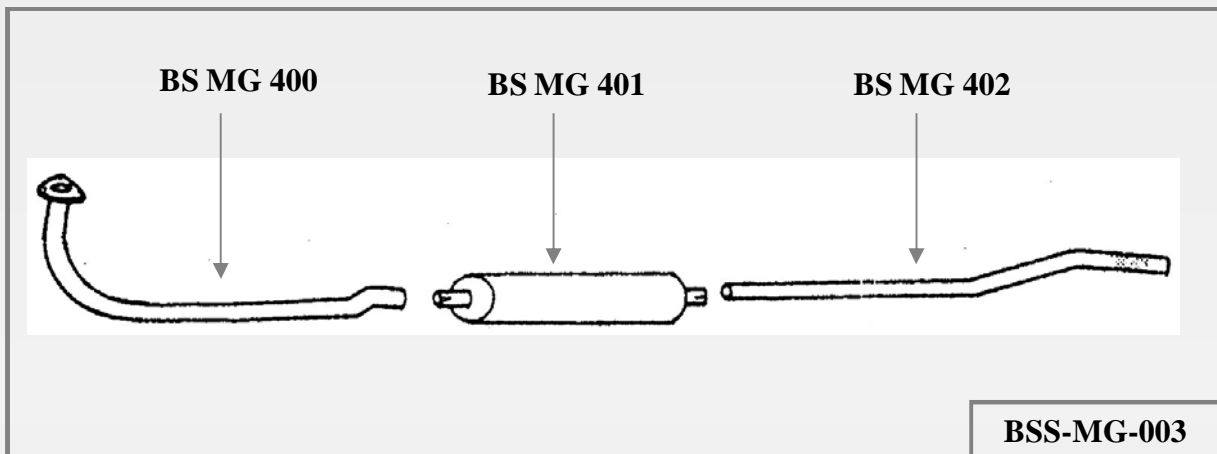



**STAINLESS STEEL EXHAUSTS**

West-Classic Tel: 0041 213 14 13 e-mail [west-classic@hotmail.com](mailto:west-classic@hotmail.com) Web: [www.west-classic.ch](http://www.west-classic.ch) / [www.west-motoren.ch](http://www.west-motoren.ch)



**MIDGET MKI SINGLE BOX 1961-64 / SPRITE MKI & MKII**  
**1959-64**

FRONT PIPE  
SILENCER AND TAIL PIPE

BS AN 56  
BS AN 219

**SYSTEM NUMBER**

**BSS-MG-004**

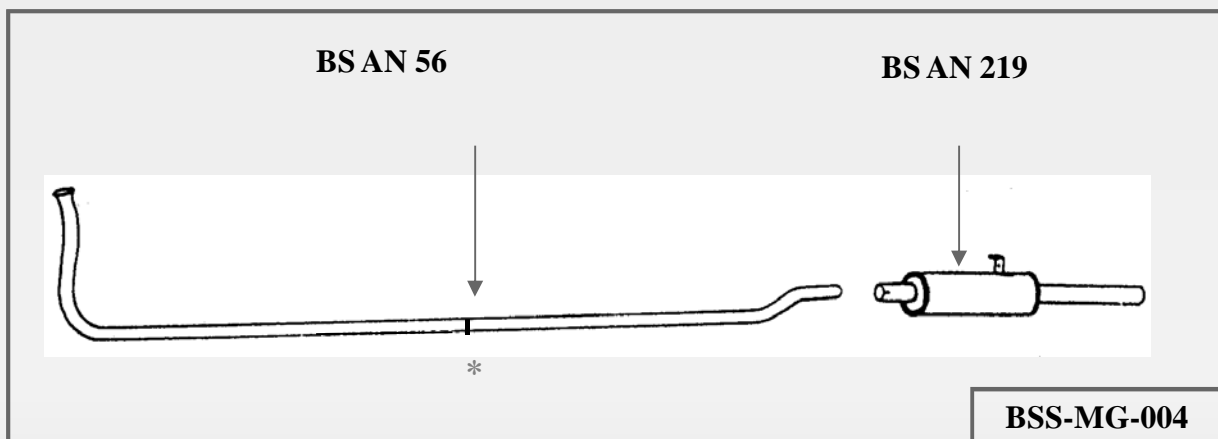

**\* Part No. BS AN 56 is now  
in two parts**



STAINLESS STEEL EXHAUSTS

West-Classic Tel: 0041 213 14 13 e-mail [west-classic@hotmail.com](mailto:west-classic@hotmail.com) Web: [www.west-classic.ch](http://www.west-classic.ch) / [www.west-motoren.ch](http://www.west-motoren.ch)

MG

**MIDGET MKI SINGLE BOX TO FIT LONG CENTRE  
BRANCH MANIFOLD**

FRONT PIPE  
SILENCER AND TAIL PIPE

BS AN 056 BB  
BS AN 219BB

SYSTEM NUMBER

BSS-MG-004M





**STAINLESS STEEL EXHAUSTS**

West-Classic Tel: 0041 213 14 13 e-mail [west-classic@hotmail.com](mailto:west-classic@hotmail.com) Web: [www.west-classic.ch](http://www.west-classic.ch) / [www.west-motoren.ch](http://www.west-motoren.ch)

**MG**

**MIDGET MKII AND MKIII SINGLE BOX 1964-69**  
**& SPRITE MKIII 1964-66**

FRONT PIPE  
SILENCER AND TAIL PIPE

BS AN 290  
BS AN 233

**SYSTEM NUMBER**

**BSS-MG-005**

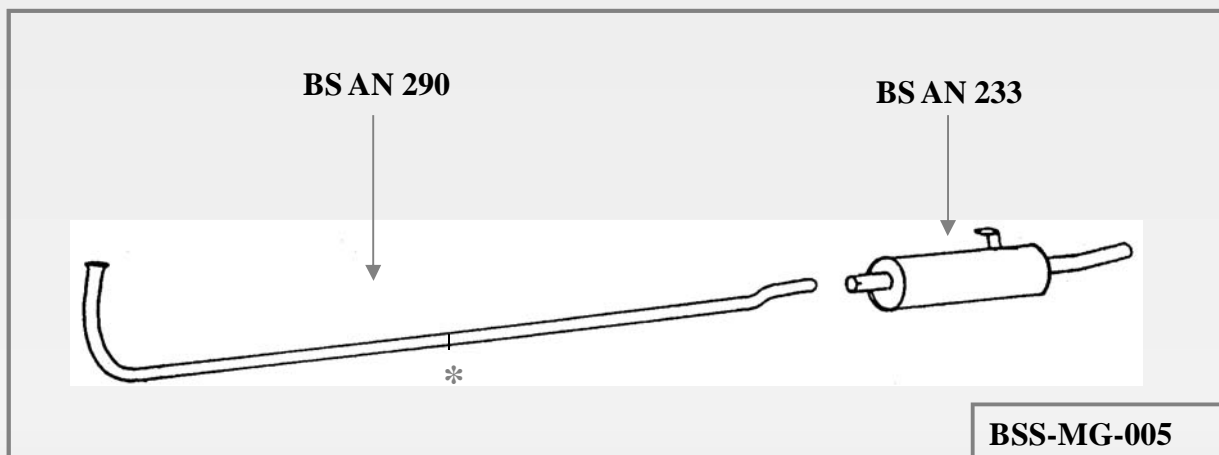

**\* Part No. BS AN 56 is now in two parts**





**STAINLESS STEEL EXHAUSTS**

West-Classic Tel: 0041 213 14 13 e-mail [west-classic@hotmail.com](mailto:west-classic@hotmail.com) Web: [www.west-classic.ch](http://www.west-classic.ch) / [www.west-motoren.ch](http://www.west-motoren.ch)

**MG**

**MIDGET MKII AND MKIII SYSTEM TO FIT LONG CENTRE BRANCH MANIFOLD**

FRONT PIPE  
SILENCER AND TAIL PIPE

BS AN 1290  
BS AN 233BB

**SYSTEM NUMBER**

**BSS-MG-005M**

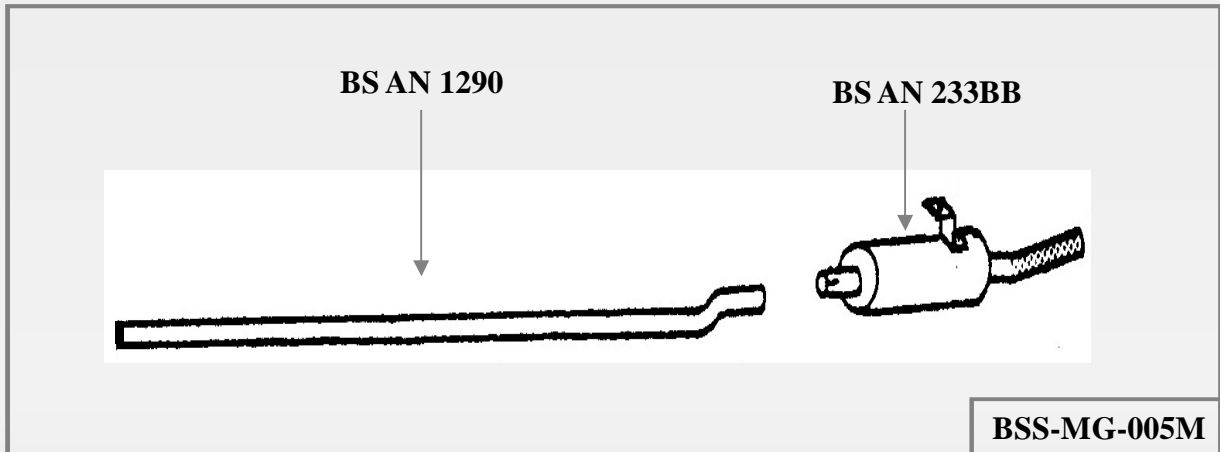





**STAINLESS STEEL EXHAUSTS**

West-Classic Tel: 0041 213 14 13 e-mail [west-classic@hotmail.com](mailto:west-classic@hotmail.com) Web: [www.west-classic.ch](http://www.west-classic.ch) / [www.west-motoren.ch](http://www.west-motoren.ch)

**MG**

**MIDGET MKII AND MKIII SINGLE BOX 1964-69**

FRONT PIPE  
SILENCER AND TAIL PIPE

BS AN 56BB  
BS AN 219BB

**SYSTEM NUMBER**

**BSS-MG-004M**

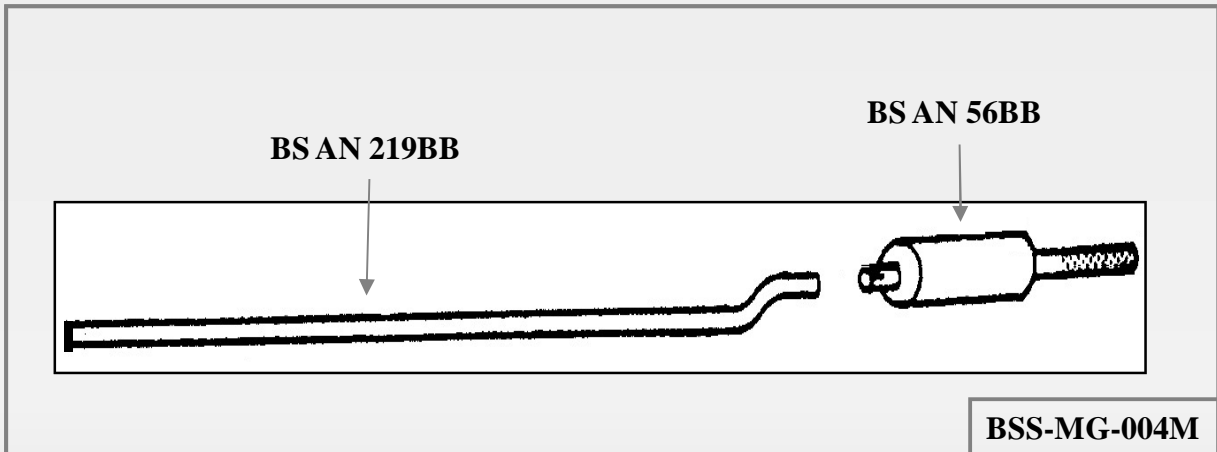



**STAINLESS STEEL EXHAUSTS**

West-Classic Tel: 0041 213 14 13 e-mail [west-classic@hotmail.com](mailto:west-classic@hotmail.com) Web: [www.west-classic.ch](http://www.west-classic.ch) / [www.west-motoren.ch](http://www.west-motoren.ch)

**MG**

**MIDGET MKIII AND MKIV 1964-1969 & SPRITE**  
**MK IV 1966-71**

FRONT PIPE  
SILENCER AND TAIL PIPE

BS AN 290  
BS AN 336

**SYSTEM NUMBER**

**BSS-MG-006**

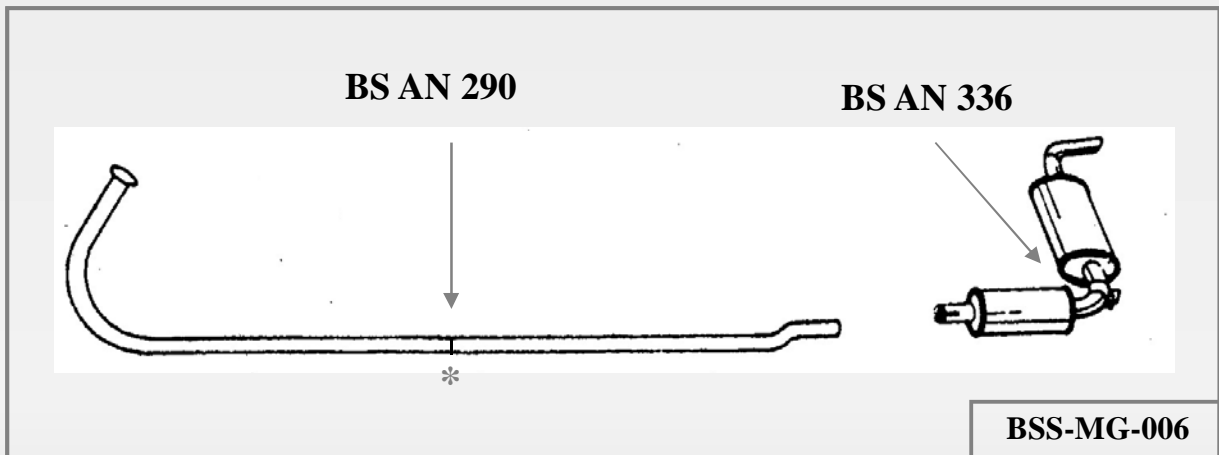

**\* Part No. BS AN 290 is now in two parts**

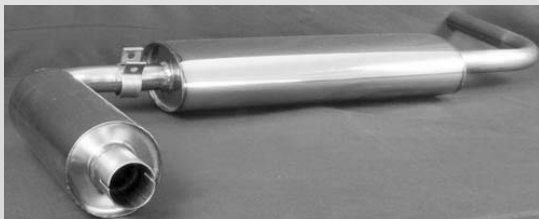



**STAINLESS STEEL EXHAUSTS**

West-Classic Tel: 0041 213 14 13 e-mail [west-classic@hotmail.com](mailto:west-classic@hotmail.com) Web: [www.west-classic.ch](http://www.west-classic.ch) / [www.west-motoren.ch](http://www.west-motoren.ch)

**MG**

**MIDGET MKIII & MKIV STUD FLANGE 1970-75**

FRONT PIPE  
TWIN SILENCER

BS AN 337  
BS AN 336

**SYSTEM NUMBER**

**BSS-MG-007**

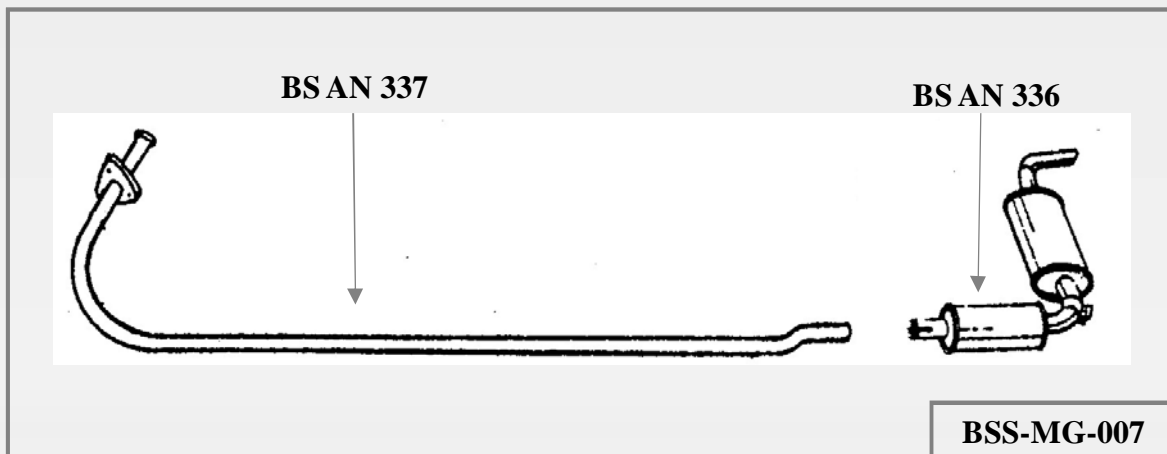



**STAINLESS STEEL EXHAUSTS**

West-Classic Tel: 0041 213 14 13 e-mail [west-classic@hotmail.com](mailto:west-classic@hotmail.com) Web: [www.west-classic.ch](http://www.west-classic.ch) / [www.west-motoren.ch](http://www.west-motoren.ch)

**MG**

**MIDGET 1500 1976-79**

FRONT PIPE  
LINK PIPE  
TWIN SILENCER

BS MG 046  
BS MG 047  
BS MG 336

**SYSTEM NUMBER**

**BSS-MG-008**

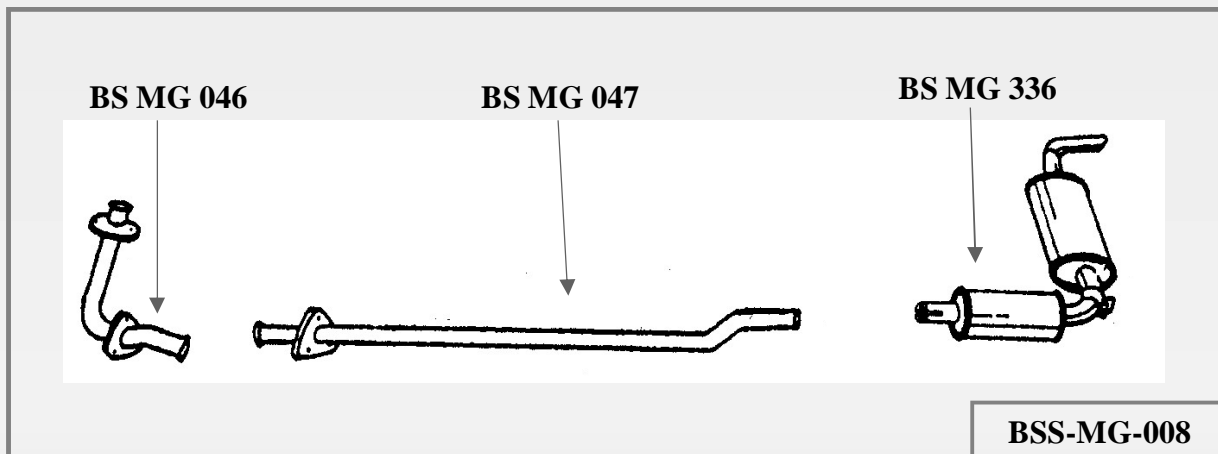



**STAINLESS STEEL EXHAUSTS**

West-Classic Tel: 0041 213 14 13 e-mail [west-classic@hotmail.com](mailto:west-classic@hotmail.com) Web: [www.west-classic.ch](http://www.west-classic.ch) / [www.west-motoren.ch](http://www.west-motoren.ch)

**MG**

**MGA 1600 1956-62**

FRONT PIPE FRONT SECTION  
FRONT PIPE REAR SECTION  
REAR SILENCER

BS MG 017A  
BS MG 017B  
BS MG 018

**SYSTEM NUMBER**

**BSS-MG-009**

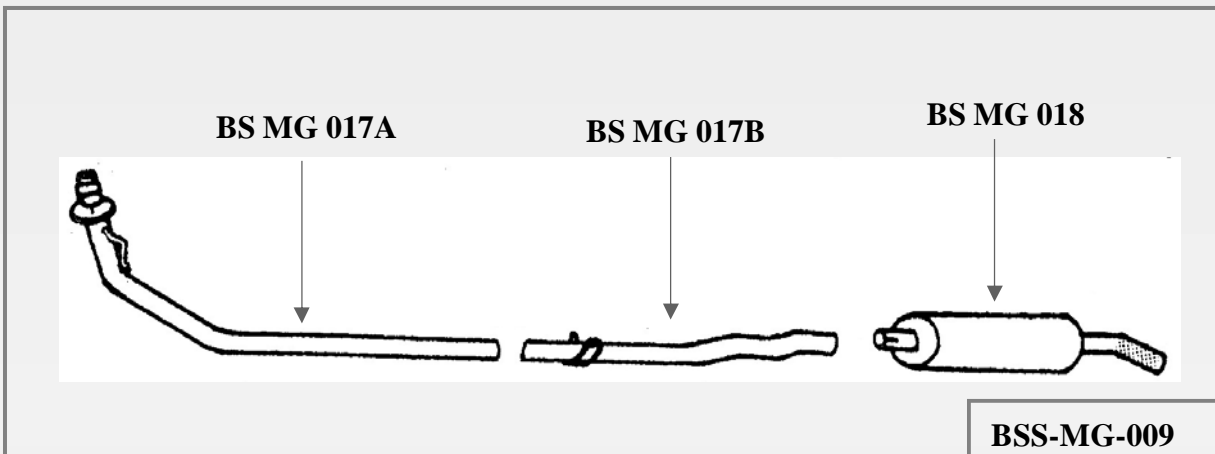



**STAINLESS STEEL EXHAUSTS**

West-Classic Tel: 0041 213 14 13 e-mail [west-classic@hotmail.com](mailto:west-classic@hotmail.com) Web: [www.west-classic.ch](http://www.west-classic.ch) / [www.west-motoren.ch](http://www.west-motoren.ch)

**MG**

**MGA TWIN CAM SYSTEM**

MGA TWIN CAM TWIN FRONT PIPE  
MGA TWIN CAM LINK PIPE  
MGA TWIN CAM REAR SILENCER

BS MG 014  
BS MG 015  
BS MG 016

**SYSTEM NUMBER**

**BSS-MG-015**

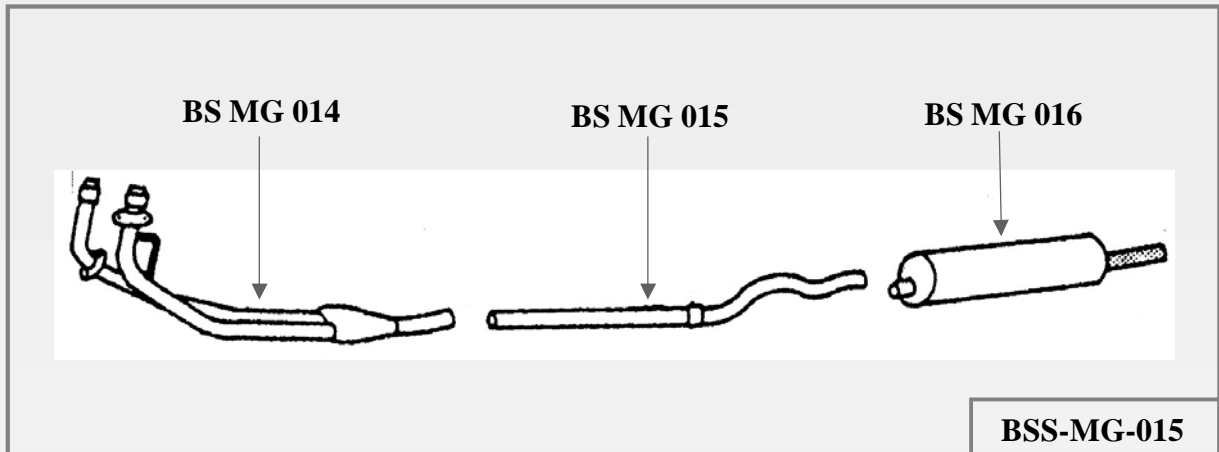



**STAINLESS STEEL EXHAUSTS**

West-Classic Tel: 0041 213 14 13 e-mail [west-classic@hotmail.com](mailto:west-classic@hotmail.com) Web: [www.west-classic.ch](http://www.west-classic.ch) / [www.west-motoren.ch](http://www.west-motoren.ch)

**MG**

**MGB CHROME STANDARD SYSTEM**

FRONT PIPE ASSEMBLY  
STANDARD SILENCER  
LINK PIPE  
REAR SILENCER

BS MG 019  
BS MG 021  
BS MG 022  
BS MG 023

**SYSTEM NUMBER**

**BSS-MG-010**

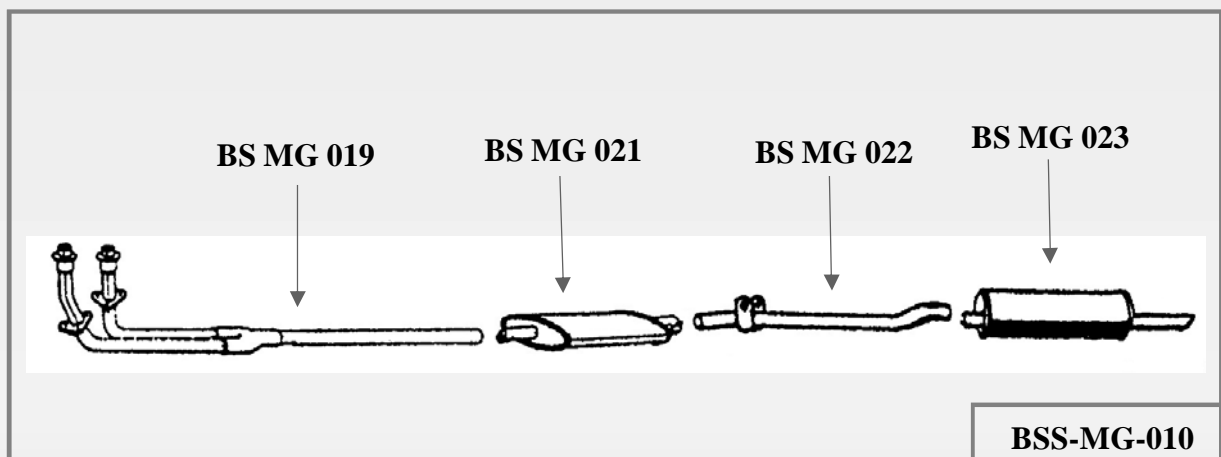



**STAINLESS STEEL EXHAUSTS**

West-Classic Tel: 0041 213 14 13 e-mail [west-classic@hotmail.com](mailto:west-classic@hotmail.com) Web: [www.west-classic.ch](http://www.west-classic.ch) / [www.west-motoren.ch](http://www.west-motoren.ch)

**MG**

**MGB CHROME BOMB SYSTEM**

FRONT PIPE ASSEMBLY  
STANDARD SILENCER  
LINK PIPE  
REAR SILENCER

BS MG 019  
BS MG 121  
BS MG 022  
BS MG 023

**SYSTEM NUMBER**

**BSS-MG-110**

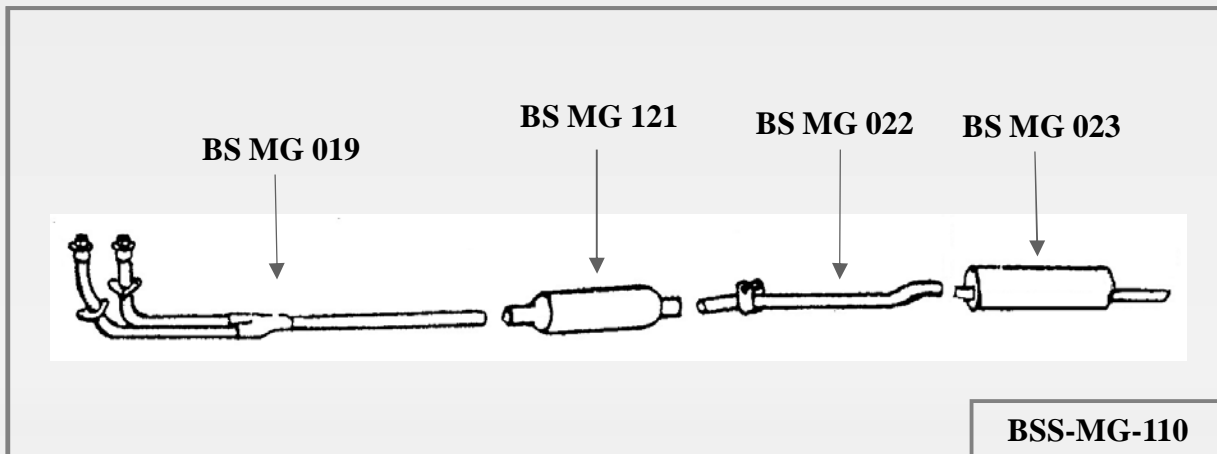





**STAINLESS STEEL EXHAUSTS**

West-Classic Tel: 0041 213 14 13 e-mail [west-classic@hotmail.com](mailto:west-classic@hotmail.com) Web: [www.west-classic.ch](http://www.west-classic.ch) / [www.west-motoren.ch](http://www.west-motoren.ch)

**MG**

**MGB CHROME SKIDDED BOMB SYSTEM**

FRONT PIPE ASSEMBLY  
SKIDDED BOMB SILENCER  
LINK PIPE  
REAR SILENCER

BS MG 019  
BS MG 221  
BS MG 022  
BS MG 023

**SYSTEM NUMBER**

**BSS-MG-210**

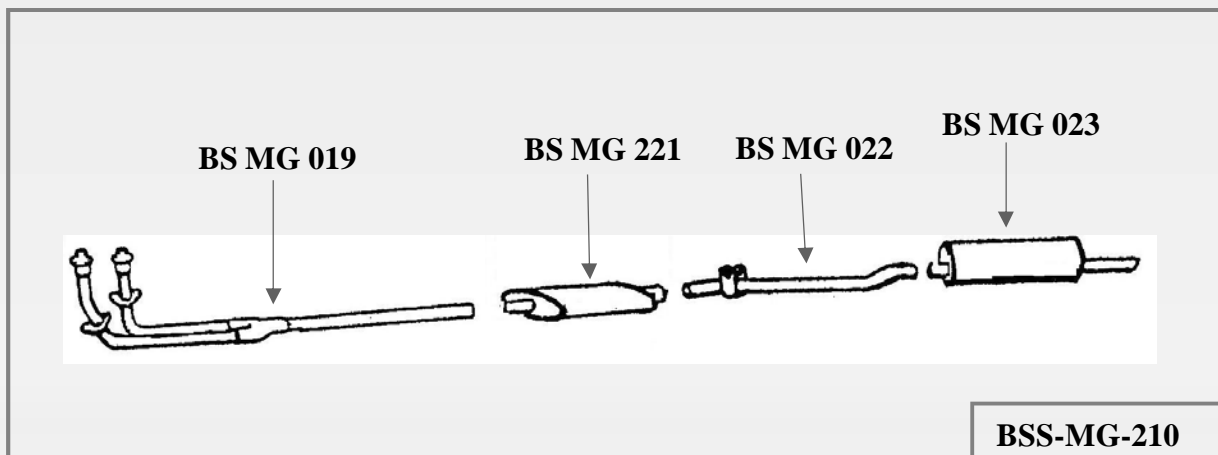



**STAINLESS STEEL EXHAUSTS**

West-Classic Tel: 0041 213 14 13 e-mail [west-classic@hotmail.com](mailto:west-classic@hotmail.com) Web: [www.west-classic.ch](http://www.west-classic.ch) / [www.west-motoren.ch](http://www.west-motoren.ch)

**MG**

**MGB CHROME STANDARD MANIFOLD SYSTEM**

MGB MANIFOLD  
MANIFOLD LINK PIPE  
STANDARD SILENCER  
LINK PIPE  
REAR SILENCER

BS MG 319  
BS MG 020  
BS MG 021  
BS MG 022  
BS MG 023

**SYSTEM NUMBER**

**BSS-MG-310**

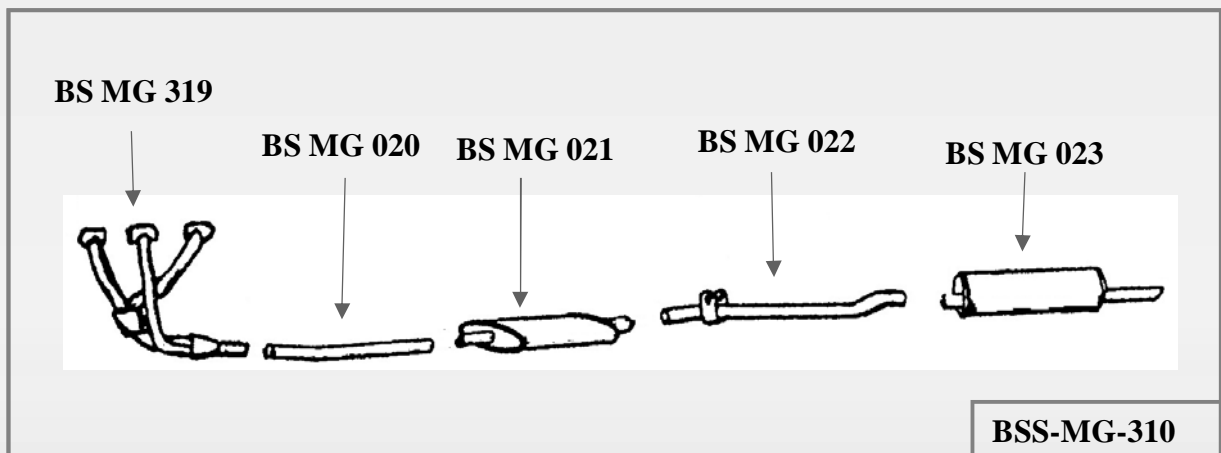



**STAINLESS STEEL EXHAUSTS**

West-Classic Tel: 0041 213 14 13 e-mail [west-classic@hotmail.com](mailto:west-classic@hotmail.com) Web: [www.west-classic.ch](http://www.west-classic.ch) / [www.west-motoren.ch](http://www.west-motoren.ch)

**MG**

**MGB CHROME SPORTS SYSTEM**

FRONT PIPE ASSEMBLY  
LINK PIPE  
REAR SILENCER BIG BORE

BS MG 193  
BS MG 320  
BS MG 321

**SYSTEM NUMBER**

**BSS-MG-193**

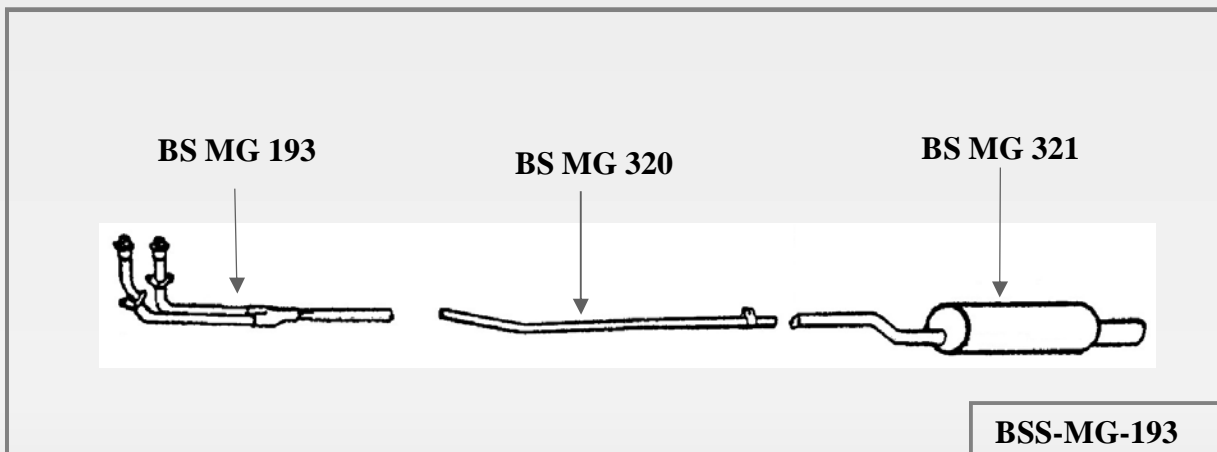



**STAINLESS STEEL EXHAUSTS**

West-Classic Tel: 0041 213 14 13 e-mail [west-classic@hotmail.com](mailto:west-classic@hotmail.com) Web: [www.west-classic.ch](http://www.west-classic.ch) / [www.west-motoren.ch](http://www.west-motoren.ch)

**MG**

**MGB CHROME FULL SPORTS MANIFOLD SYSTEM**

MGB MANIFOLD  
LINK PIPE  
REAR SILENCER BIG BORE

BS MG 319  
BS MG 320  
BS MG 321

**SYSTEM NUMBER**

**BSS-MG-320**

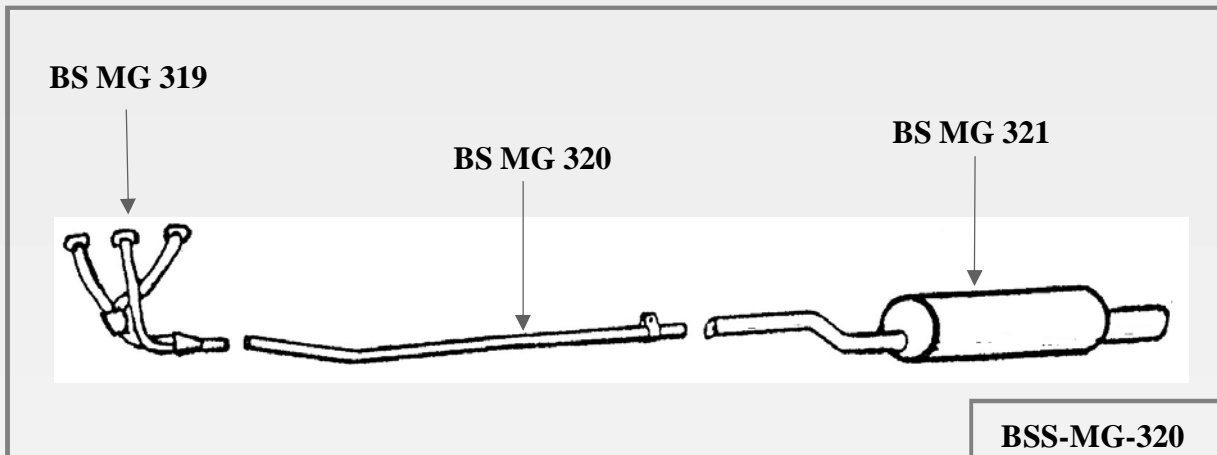



**STAINLESS STEEL EXHAUSTS**

West-Classic Tel: 0041 213 14 13 e-mail [west-classic@hotmail.com](mailto:west-classic@hotmail.com) Web: [www.west-classic.ch](http://www.west-classic.ch) / [www.west-motoren.ch](http://www.west-motoren.ch)



**MGB CHROME U.S. SPEC. SYSTEM**

FRONT PIPE	BS MG 008
LINK PIPE	BS MG 009
STANDARD SILENCER	BS MG 021
LINK PIPE	BS MG 022
REAR SILENCER	BS MG 023
<b>OR REPLACE STANDARD SILENCER BS MG 021 WITH</b>	
BOMB SILENCER	BS MG 121
SKIDDED BOMB SILENCER	BS MG 221
<b>SYSTEM NUMBER</b>	<b>BSS-MG-342</b>

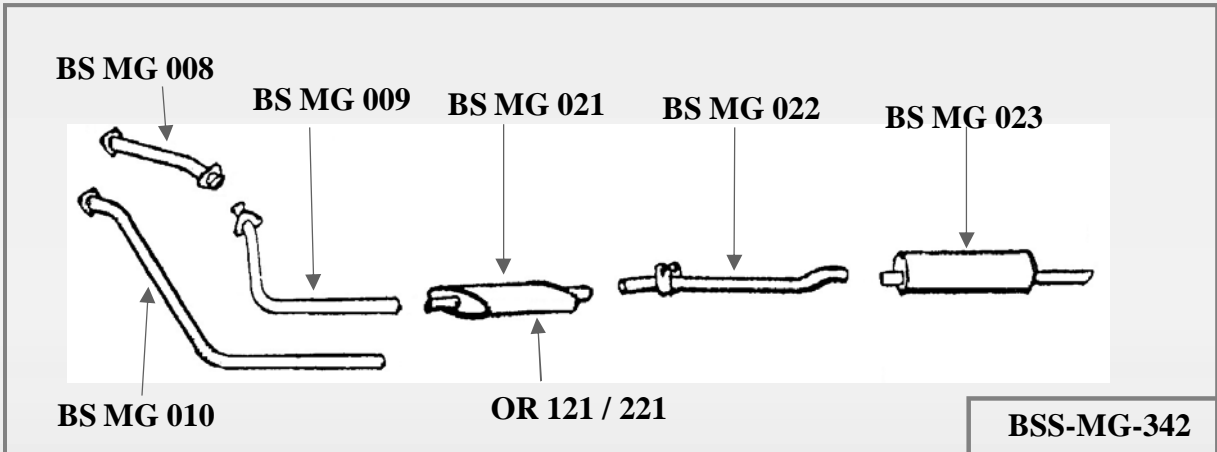

**BS MG 010 REPLACES 8 & 9**

**MGB TWIN TAIL PIPE BS MG 040  
BS MG 40 REPLACES BS MG 023 ON CHROME BUMPER**





**STAINLESS STEEL EXHAUSTS**

West-Classic Tel: 0041 213 14 13 e-mail [west-classic@hotmail.com](mailto:west-classic@hotmail.com) Web: [www.west-classic.ch](http://www.west-classic.ch) / [www.west-motoren.ch](http://www.west-motoren.ch)

**MG**

**MGB CHROME MANIFOLD BOMB SYSTEM**

MG MANIFOLD  
MANIFOLD LINK PIPE  
BOMB SILENCER  
LINK PIPE  
REAR SILENCER

BS MG 319  
BS MG 020  
BS MG 121  
BS MG 022  
BS MG 023

**SYSTEM NUMBER**

**BSS-MG-410**

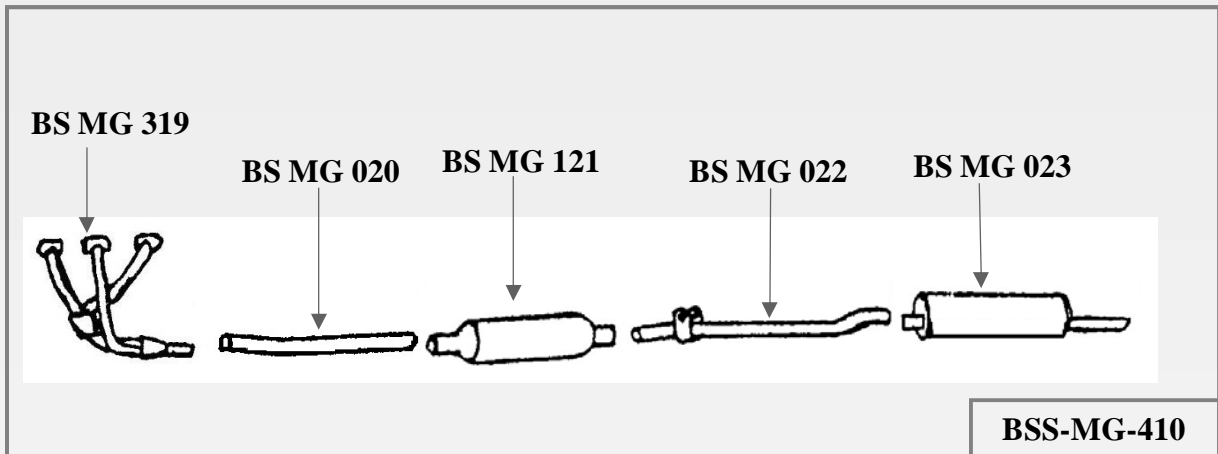

**BSMG319 TUBULAR MANIFOLD**





STAINLESS STEEL EXHAUSTS

West-Classic Tel: 0041 213 14 13 e-mail [west-classic@hotmail.com](mailto:west-classic@hotmail.com) Web: [www.west-classic.ch](http://www.west-classic.ch) / [www.west-motoren.ch](http://www.west-motoren.ch)



## MGB CHROME MANIFOLD SKIDDED BOMB SYSTEM

MGB MANIFOLD  
MANIFOLD LINK PIPE  
SKIDDED BOMB SILENCER  
LINK PIPE  
REAR SILENCER

BS MG 319  
BS MG 020  
BS MG 221  
BS MG 022  
BS MG 023

SYSTEM NUMBER

**BSS-MG-510**

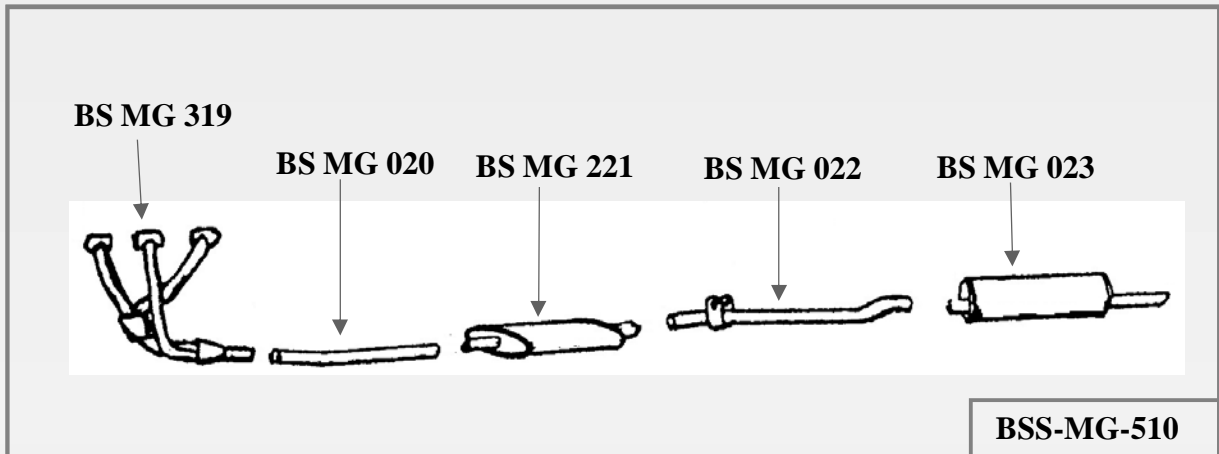

### **BSMG319 TUBULAR MANIFOLD**





STAINLESS STEEL EXHAUSTS

West-Classic Tel: 0041 213 14 13 e-mail [west-classic@hotmail.com](mailto:west-classic@hotmail.com) Web: [www.west-classic.ch](http://www.west-classic.ch) / [www.west-motoren.ch](http://www.west-motoren.ch)



**MGB RUBBER STANDARD SYSTEM**

FRONT PIPE ASSEMBLY  
STANDARD SILENCER  
LINK PIPE  
REAR SILENCER

BS MG 019  
BS MG 021  
BS MG 027  
BS MG 028

SYSTEM NUMBER

BSS-MG-011

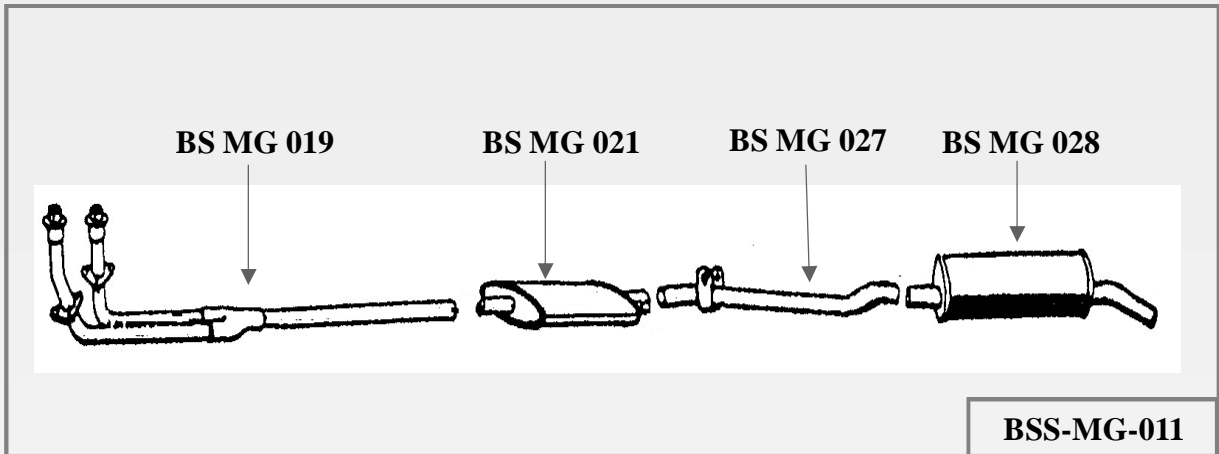

BSMG040 TWIN TAIL PIPE REPLACES BSMG028 ON RUBBER BUMPER  
ENSURE CLEARANCE FROM RUBBER BUMPER TO AVOID HEAT  
DAMAGE







STAINLESS STEEL EXHAUSTS

West-Classic Tel: 0041 213 14 13 e-mail [west-classic@hotmail.com](mailto:west-classic@hotmail.com) Web: [www.west-classic.ch](http://www.west-classic.ch) / [www.west-motoren.ch](http://www.west-motoren.ch)



**MGB RUBBER BOMB SYSTEM**

FRONT PIPE ASSEMBLY  
BOMB SILENCER  
LINK PIPE  
REAR SILENCER

BS MG 019  
BS MG 121  
BS MG 027  
BS MG 028

**SYSTEM NUMBER**

**BSS-MG-111**

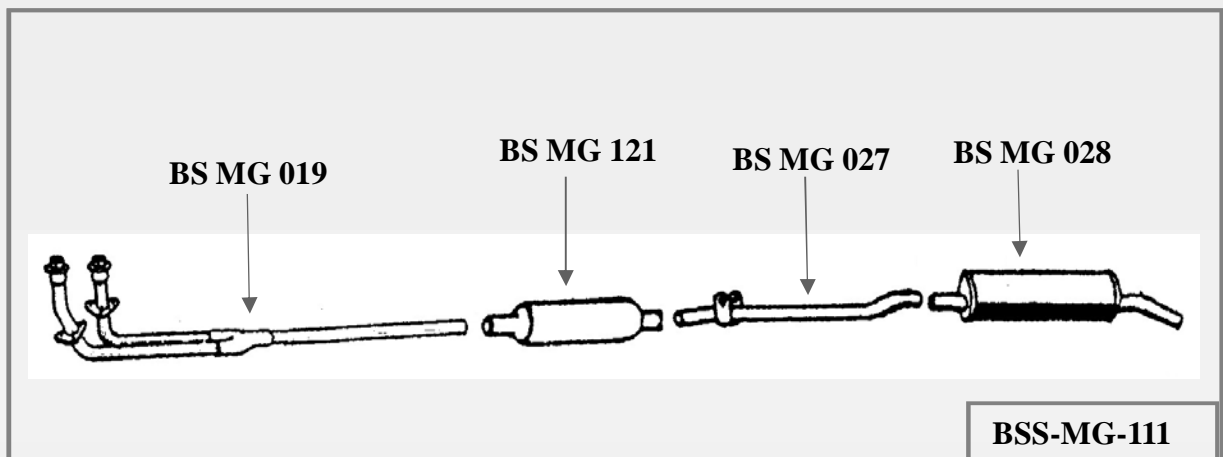

BSMG040 TWIN TAIL PIPE REPLACES BSMG028 ON RUBBER BUMPER  
ENSURE CLEARANCE FROM RUBBER BUMPER TO AVOID HEAT  
DAMAGE





STAINLESS STEEL EXHAUSTS

West-Classic Tel: 0041 213 14 13 e-mail [west-classic@hotmail.com](mailto:west-classic@hotmail.com) Web: [www.west-classic.ch](http://www.west-classic.ch) / [www.west-motoren.ch](http://www.west-motoren.ch)

MG

## MGB RUBBER SKIDDED BOMB SYSTEM

FRONT PIPE ASSEMBLY  
SKIDDED BOMB SILENCER  
LINK PIPE  
REAR SILENCER

BS MG 019  
BS MG 221  
BS MG 027  
BS MG 028

SYSTEM NUMBER

BSS-MG-211

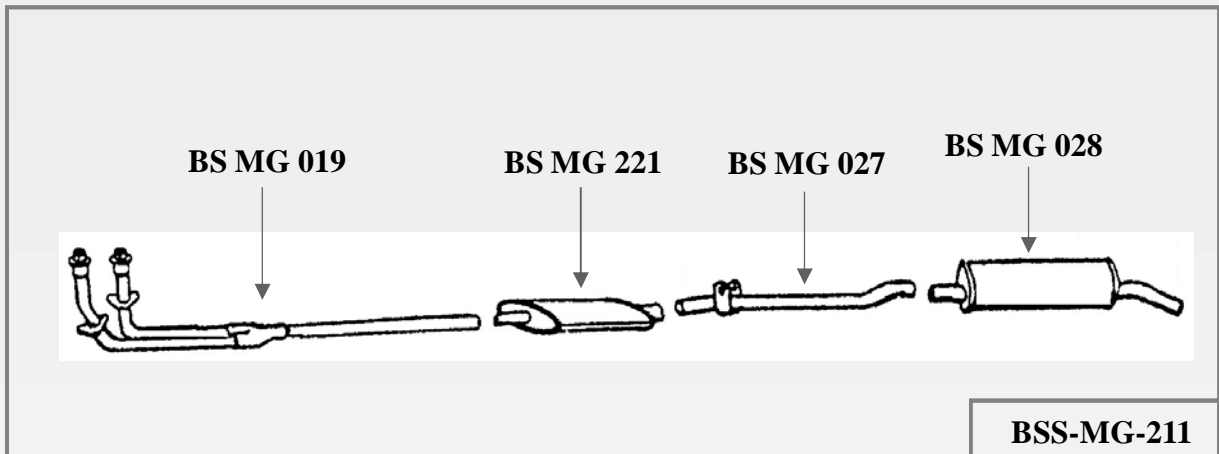

BSMG040 TWIN TAIL PIPE REPLACES BSMG028 ON RUBBER BUMPER  
ENSURE CLEARANCE FROM RUBBER BUMPER TO AVOID HEAT  
DAMAGE





STAINLESS STEEL EXHAUSTS

West-Classic Tel: 0041 213 14 13 e-mail [west-classic@hotmail.com](mailto:west-classic@hotmail.com) Web: [www.west-classic.ch](http://www.west-classic.ch) / [www.west-motoren.ch](http://www.west-motoren.ch)



## MGB RUBBER STANDARD MANIFOLD SYSTEM

MGB MANIFOLD  
MANIFOLD LINK PIPE  
STANDARD SILENCER  
LINK PIPE  
REAR SILENCER

BS MG 319  
BS MG 020  
BS MG 021  
BS MG 027  
BS MG 028

SYSTEM NUMBER

**BSS-MG-311**

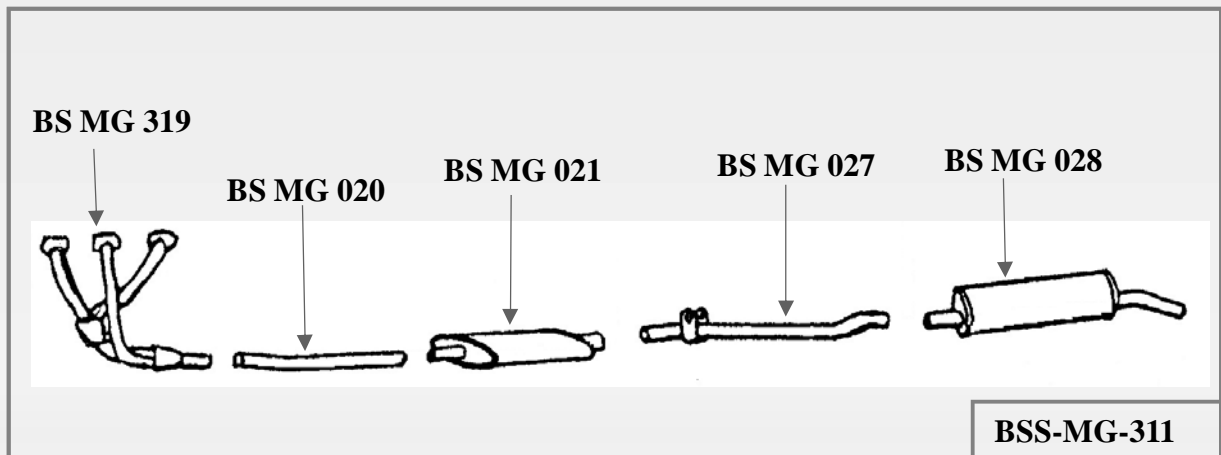

**BSMG040** TWIN TAIL PIPE REPLACES **BSMG028** ON RUBBER BUMPER  
ENSURE CLEARANCE FROM RUBBER BUMPER TO AVOID HEAT  
DAMAGE



### **BSMG319 TUBULAR MANIFOLD**





**STAINLESS STEEL EXHAUSTS**

West-Classic Tel: 0041 213 14 13 e-mail [west-classic@hotmail.com](mailto:west-classic@hotmail.com) Web: [www.west-classic.ch](http://www.west-classic.ch) / [www.west-motoren.ch](http://www.west-motoren.ch)

**MG**

**MGB RUBBER SPORTS SYSTEM**

FRONT PIPE ASSEMBLY  
LINK PIPE  
REAR SILENCER BIS BORE

BS MG 193  
BS MG 320  
BS MG 322

**SYSTEM NUMBER**

**BSS-MG-194**

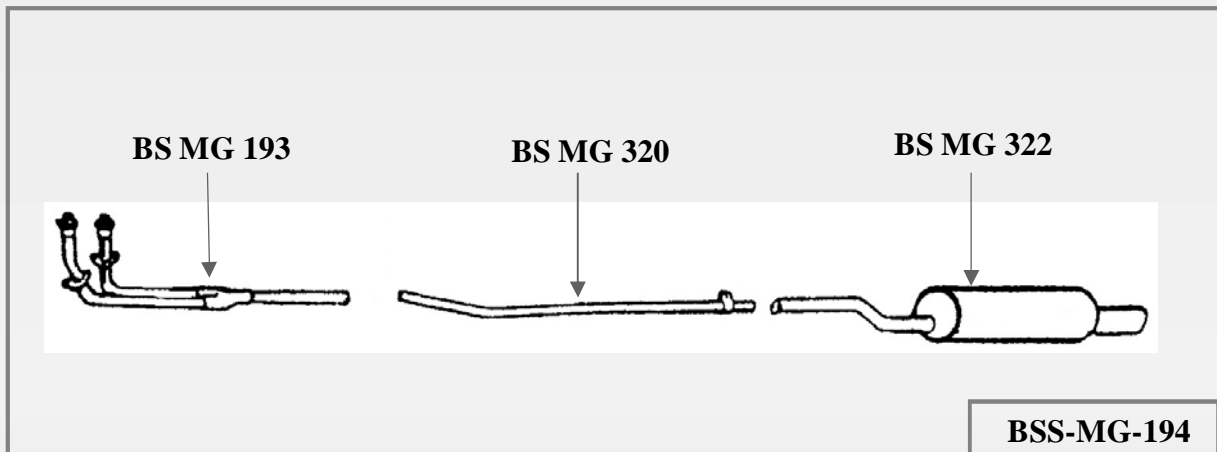



**STAINLESS STEEL EXHAUSTS**

West-Classic Tel: 0041 213 14 13 e-mail [west-classic@hotmail.com](mailto:west-classic@hotmail.com) Web: [www.west-classic.ch](http://www.west-classic.ch) / [www.west-motoren.ch](http://www.west-motoren.ch)

**MG**

**MGB RUBBER FULL SPORTS MANIFOLD SYSTEM**

FRONT PIPE ASSEMBLY  
LINK PIPE  
REAR SILENCER BIG BORE

BS MG 319  
BS MG 320  
BS MG 322

**SYSTEM NUMBER**

**BSS-MG-322**

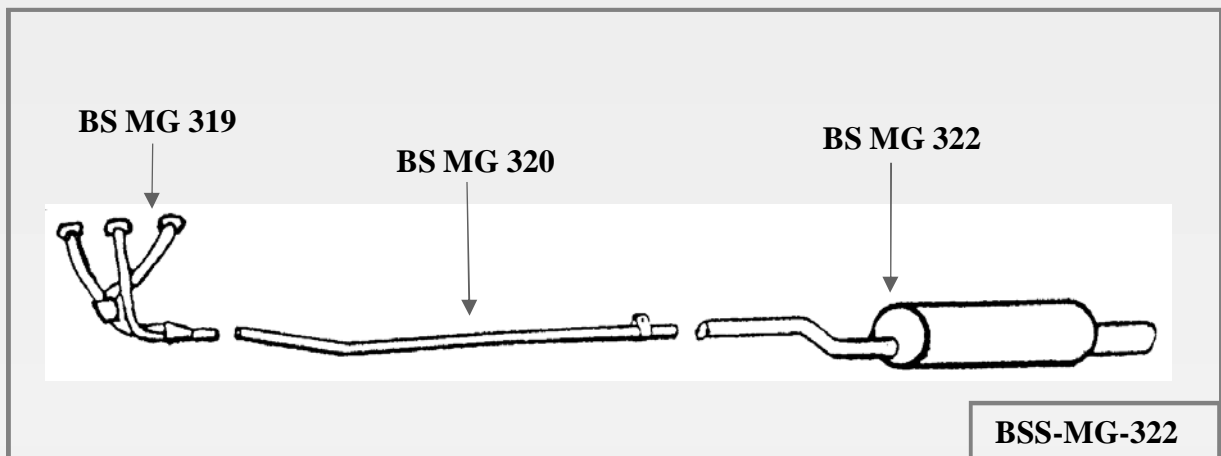



**STAINLESS STEEL EXHAUSTS**

West-Classic Tel: 0041 213 14 13 e-mail [west-classic@hotmail.com](mailto:west-classic@hotmail.com) Web: [www.west-classic.ch](http://www.west-classic.ch) / [www.west-motoren.ch](http://www.west-motoren.ch)



**MGB RUBBER FULL SPORTS MANIFOLD SYSTEM**

- |                                                    |           |
|----------------------------------------------------|-----------|
| FRONT PIPE                                         | BS MG 008 |
| LINK PIPE                                          | BS MG 009 |
| STANDARD SILENCER                                  | BS MG 021 |
| LINK PIPE                                          | BS MG 027 |
| REAR SILENCER                                      | BS MG 028 |
| <b>OR REPLACE STANDARD SILENCER BS MG 021 WITH</b> |           |
| BOMB SILENCER                                      | BS MG 121 |
| SKIDDED BOMB SILENCER                              | BS MG 221 |

**SYSTEM NUMBER**

**BSS-MG-343**

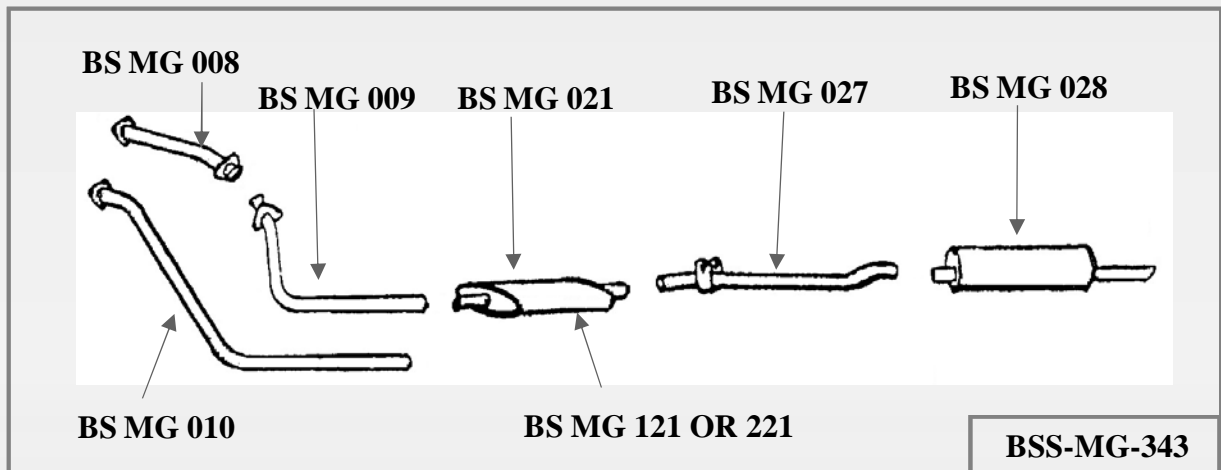

**BS MG 010 REPLACES BS MG 008 AND 009**

**MGB TWIN TAIL PIPE BS MG 040**

**BS MG 40 REPLACES BS MG 023 ON RUBBER BUMPER**





STAINLESS STEEL EXHAUSTS

West-Classic Tel: 0041 213 14 13 e-mail [west-classic@hotmail.com](mailto:west-classic@hotmail.com) Web: [www.west-classic.ch](http://www.west-classic.ch) / [www.west-motoren.ch](http://www.west-motoren.ch)



**MGB RUBBER MANIFOLD BOMB SYSTEM**

MGB MANIFOLD  
MANIFOLD LINK PIPE  
BOMB SILENCER  
LINK PIPE  
REAR SILENCER

BS MG 319  
BS MG 020  
BS MG 121  
BS MG 027  
BS MG 028

**SYSTEM NUMBER**

**BSS-MG-411**

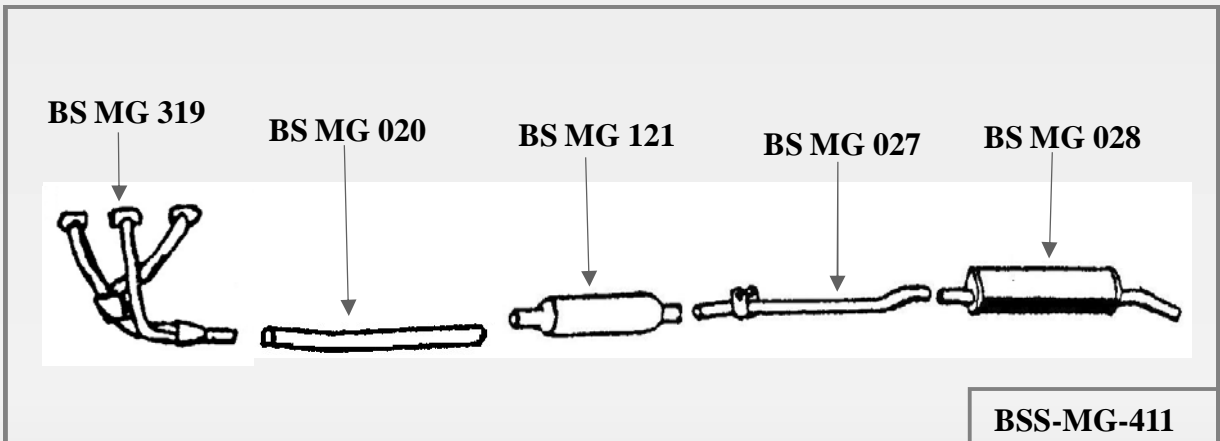

REPLACES BSMG028 ON RUBBER BUMPER ENSURE CLEARANCE FROM RUBBER BUMPER TO AVOID HEAT DAMAGE





STAINLESS STEEL EXHAUSTS

West-Classic Tel: 0041 213 14 13 e-mail [west-classic@hotmail.com](mailto:west-classic@hotmail.com) Web: [www.west-classic.ch](http://www.west-classic.ch) / [www.west-motoren.ch](http://www.west-motoren.ch)



**MGB RUBBER MANIFOLD SKIDDED BOMB SYSTEM**

MGB MANIFOLD  
MANIFOLD LINK PIPE  
BOMB SILENCER  
LINK PIPE  
REAR SILENCER

BS MG 319  
BS MG 020  
BS MG 221  
BS MG 027  
BS MG 028

**SYSTEM NUMBER**

**BSS-MG-511**

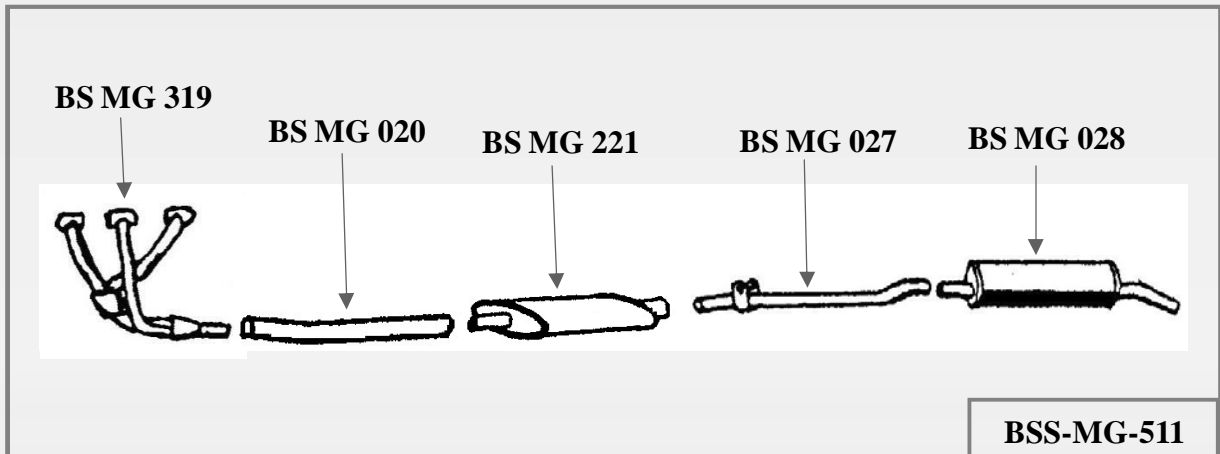

BSMG040 REPLACES BSMG028 ON RUBBER BUMPER ENSURE CLEARANCE FROM RUBBER BUMPER TO AVOID HEAT DAMAGE

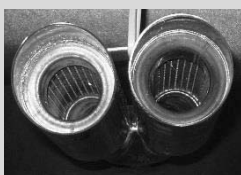

MANUFACTURED IN THE UK BY EXPERIENCED HIGHLY SKILLED CRAFTSMAN







**STAINLESS STEEL EXHAUSTS**

West-Classic Tel: 0041 213 14 13 e-mail [west-classic@hotmail.com](mailto:west-classic@hotmail.com) Web: [www.west-classic.ch](http://www.west-classic.ch) / [www.west-motoren.ch](http://www.west-motoren.ch)

**MG**

**MGC ROADSTER/GT STANDARD SYSTEM 1969-70**

FRONT PIPE ASSEMBLY  
MIDDLE BOX ASSEMBLY  
REAR SILENCER ASSEMBLY

BS MG 128  
BS MG 129A  
BS MG 129B

**SYSTEM NUMBER**

**BSS-MG-012**

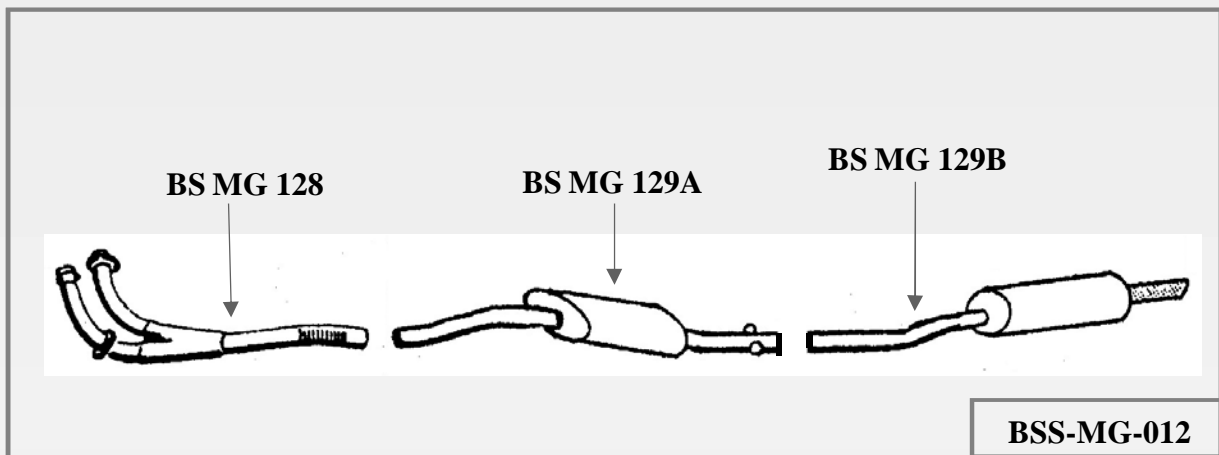



**STAINLESS STEEL EXHAUSTS**

West-Classic Tel: 0041 213 14 13 e-mail [west-classic@hotmail.com](mailto:west-classic@hotmail.com) Web: [www.west-classic.ch](http://www.west-classic.ch) / [www.west-motoren.ch](http://www.west-motoren.ch)

**MG**

**MGC ROADSTER GT SINGLE BOX SPORTS SYSTEM**

FRONT PIPE ASSEMBLY  
LINK PIPE  
REAR SILENCER ASSEMBLY

BS MG 128  
BS MG 329A  
BS MG 329B

**SYSTEM NUMBER**

**BSS-MG-360**

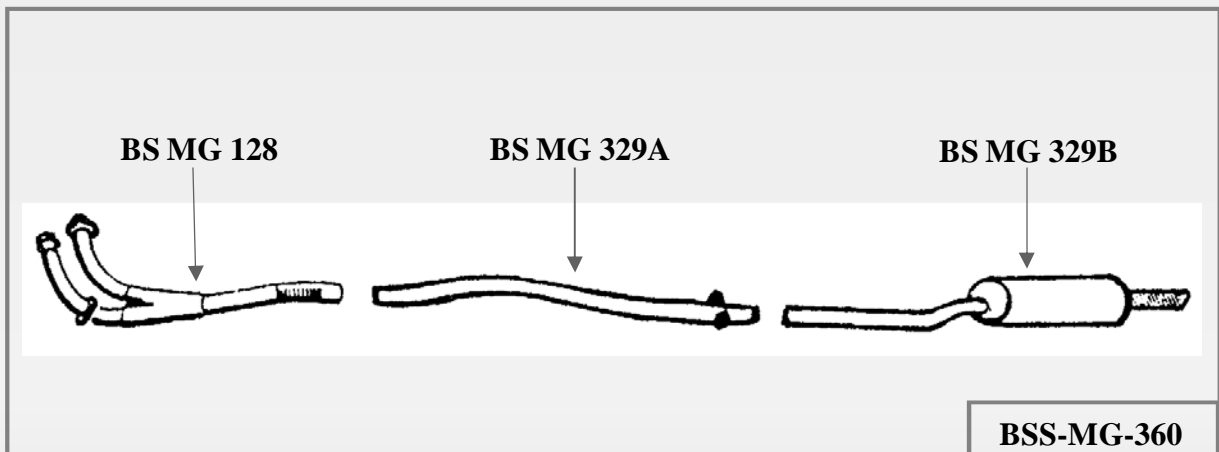



**STAINLESS STEEL EXHAUSTS**

West-Classic Tel: 0041 213 14 13 e-mail [west-classic@hotmail.com](mailto:west-classic@hotmail.com) Web: [www.west-classic.ch](http://www.west-classic.ch) / [www.west-motoren.ch](http://www.west-motoren.ch)

**MG**

**MGB V8 CHROME BUMBER 1973-75**

MGB V8 FRONT PIPES  
MGB V8 MIDDLE SILENCER ASSMBEBLY CHROME  
MGB V8 REAR SILENCER ASSEMBLY CHROME

BS MG 141  
BS MG 048A  
BS MG 048B

**SYSTEM NUMBER**

**BSS-MG-013**

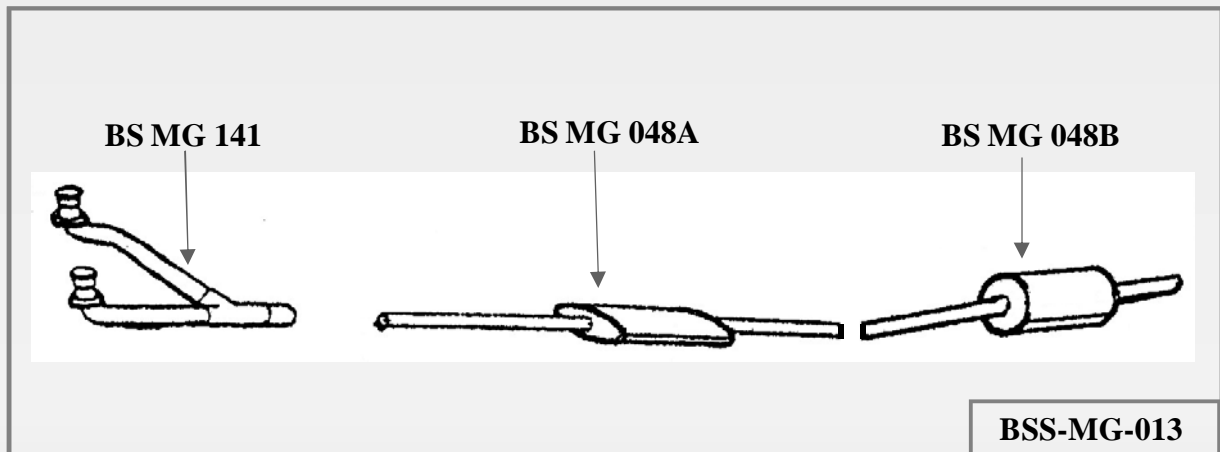



**STAINLESS STEEL EXHAUSTS**

West-Classic Tel: 0041 213 14 13 e-mail [west-classic@hotmail.com](mailto:west-classic@hotmail.com) Web: [www.west-classic.ch](http://www.west-classic.ch) / [www.west-motoren.ch](http://www.west-motoren.ch)

**MG**

**MGB V8 RUBBER BUMPER 1975-ON**

MGB V8 FRONT PIPES  
MGB V8 MIDDLE SILENCER ASSEMBLY RUBBER  
MGB V8 SILENCER ASSEMBLY RUBBER

BS MG 141  
BS MG 049A  
BS MG 049B

**SYSTEM NUMBER**

**BSS-MG-014**

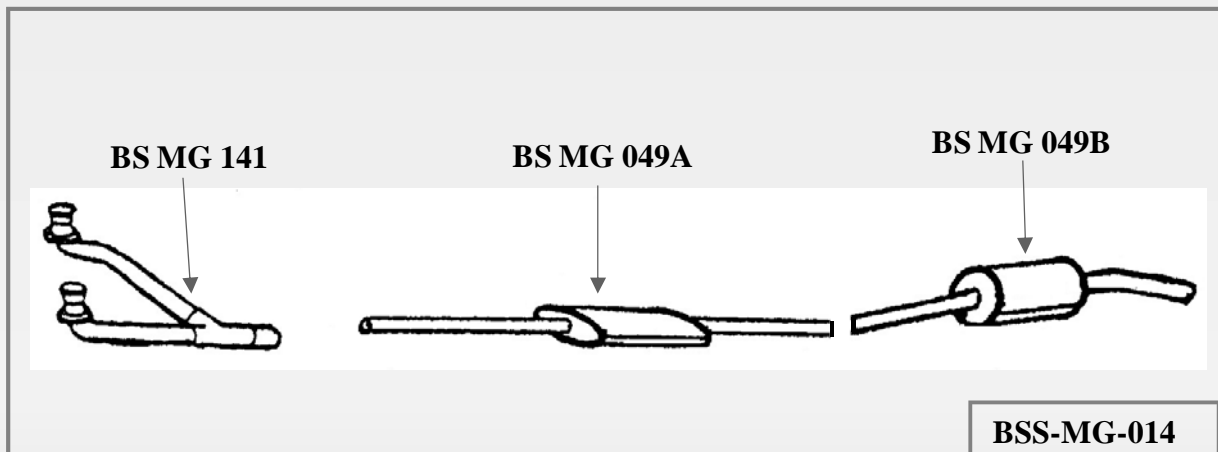



**STAINLESS STEEL EXHAUSTS**

West-Classic Tel: 0041 213 14 13 e-mail [west-classic@hotmail.com](mailto:west-classic@hotmail.com) Web: [www.west-classic.ch](http://www.west-classic.ch) / [www.west-motoren.ch](http://www.west-motoren.ch)

**ROVER**

**ROVER P4 60 1954-59, P4 75,90 1953-55**

FRONT PIPE  
CONNECTING PIPE  
SILENCER  
TAIL PIPE

BS RR 036  
BS RR 024  
BS RR 025  
BS RR 035

**SYSTEM NUMBER**

**BSS-RR001**

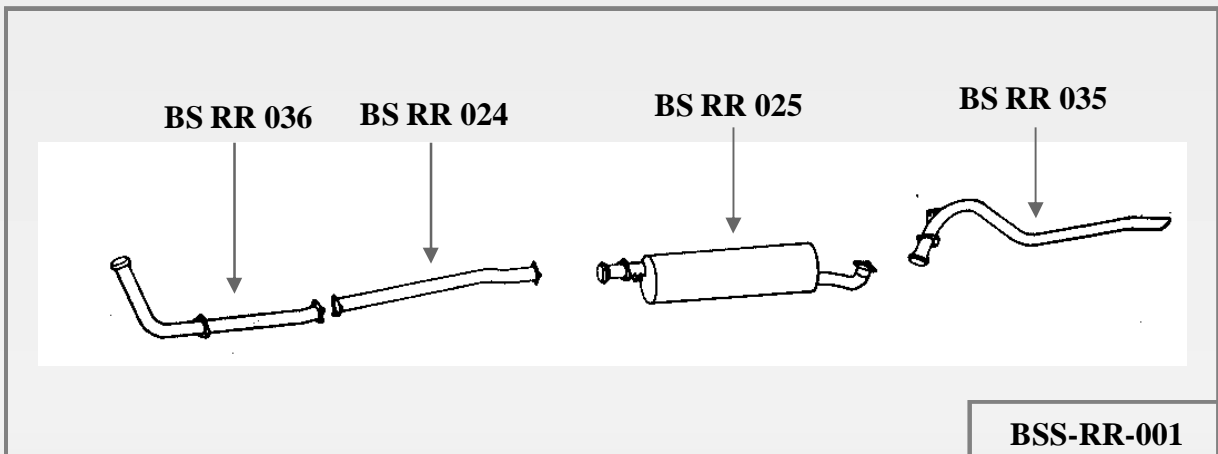



**STAINLESS STEEL EXHAUSTS**

West-Classic Tel: 0041 213 14 13 e-mail [west-classic@hotmail.com](mailto:west-classic@hotmail.com) Web: [www.west-classic.ch](http://www.west-classic.ch) / [www.west-motoren.ch](http://www.west-motoren.ch)

**ROVER**

**ROVER P4 80 1960-62**

FRONT PIPE  
CONNECTING PIPE  
SILENCER  
TAIL PIPE

BS RR 036  
BS RR 024  
BS RR 025  
BS RR 035

**SYSTEM NUMBER**

**BSS-RR-002**

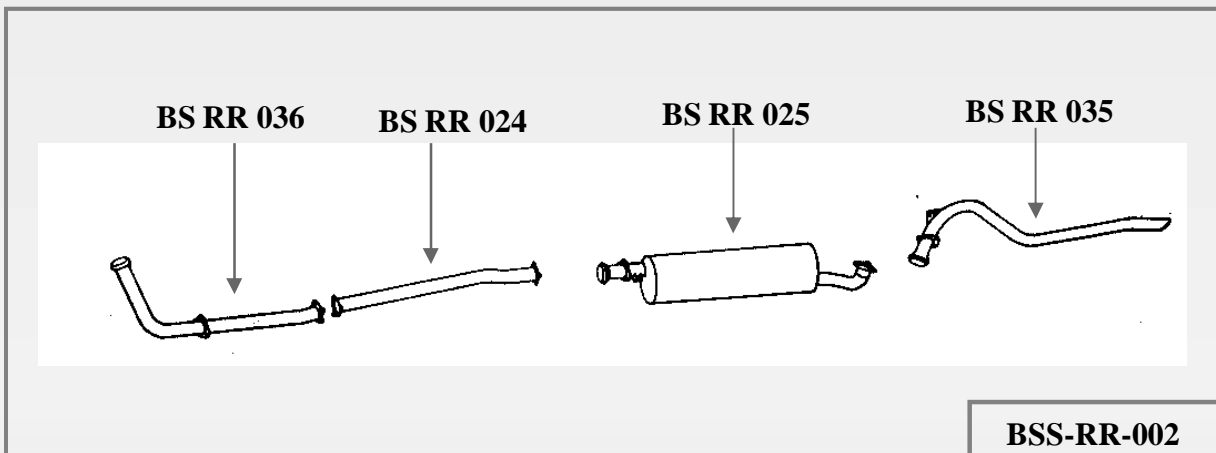



**STAINLESS STEEL EXHAUSTS**

West-Classic Tel: 0041 213 14 13 e-mail [west-classic@hotmail.com](mailto:west-classic@hotmail.com) Web: [www.west-classic.ch](http://www.west-classic.ch) / [www.west-motoren.ch](http://www.west-motoren.ch)

**ROVER**

**ROVER P4 75, 90 1955-59 P4 95 1963-64, P4 100 1960-62**

FRONT PIPE  
CONNECTING PIPE  
SILENCER  
TAIL PIPE

BS RR 036  
BS RR 024  
BS RR 027  
BS RR 035

**SYSTEM NUMBER**

**BSS-RR-003**

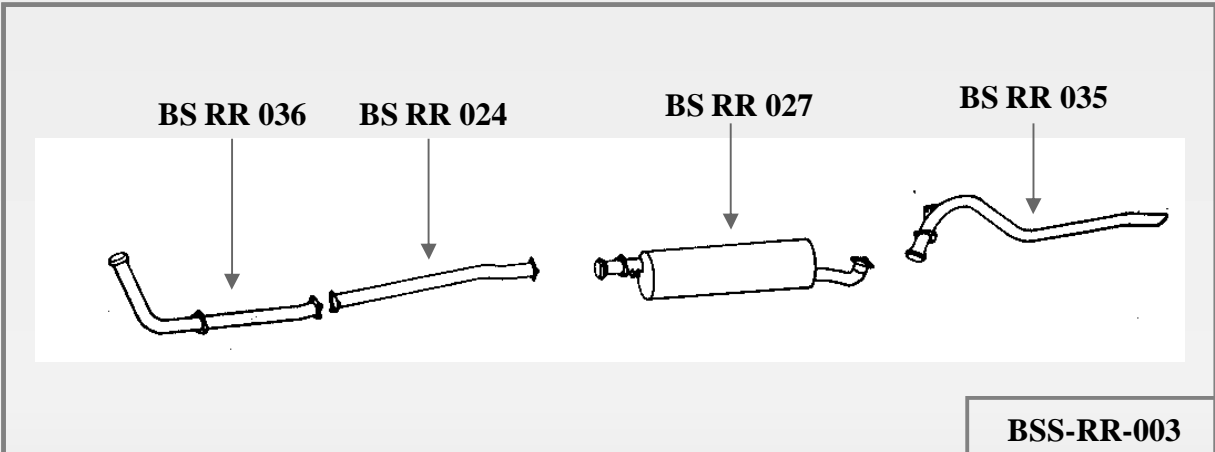



**STAINLESS STEEL EXHAUSTS**

West-Classic Tel: 0041 213 14 13 e-mail [west-classic@hotmail.com](mailto:west-classic@hotmail.com) Web: [www.west-classic.ch](http://www.west-classic.ch) / [www.west-motoren.ch](http://www.west-motoren.ch)

**ROVER**

**ROVER P4 80 1960-62**

FRONT PIPE  
CONNECTING PIPE  
SILENCER  
TAIL PIPE

BS RR 034  
BS RR 024  
BS RR 025  
BS RR 035

**SYSTEM NUMBER**

**BSS-RR-004**

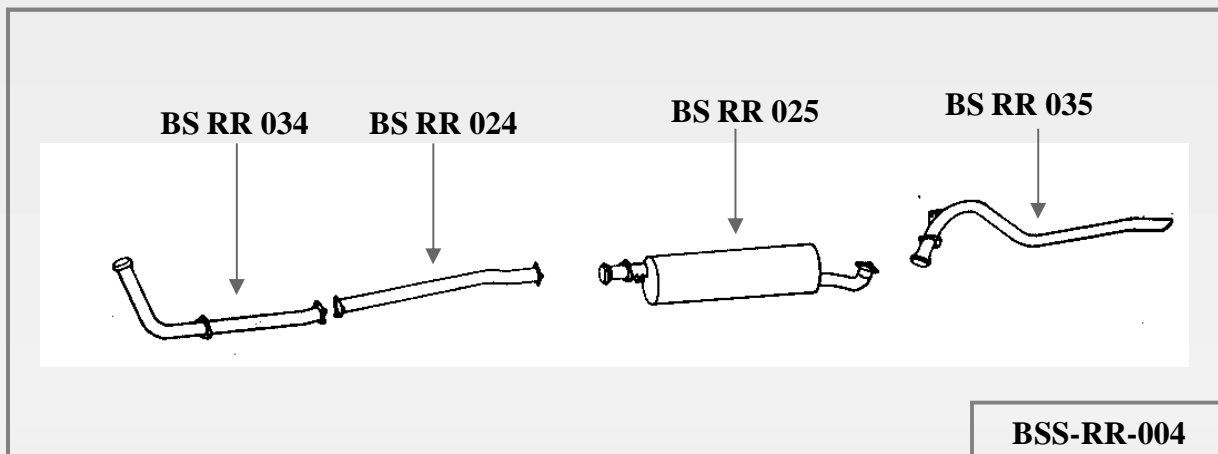





**STAINLESS STEEL EXHAUSTS**

West-Classic Tel: 0041 213 14 13 e-mail [west-classic@hotmail.com](mailto:west-classic@hotmail.com) Web: [www.west-classic.ch](http://www.west-classic.ch) / [www.west-motoren.ch](http://www.west-motoren.ch)

**ROVER**

**ROVER P4 105R 1956-59**

FRONT PIPE  
CONNECTING PIPE  
SILENCER  
TAIL PIPE

BS RR 052  
BS RR 031  
BS RR 032  
BS RR 033

**SYSTEM NUMBER**

**BSS-RR-005**

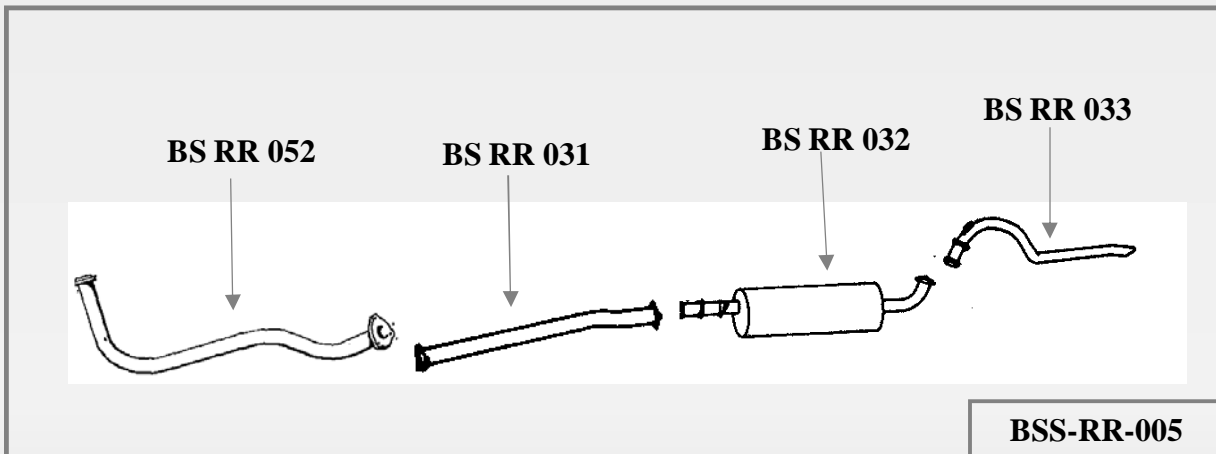



**STAINLESS STEEL EXHAUSTS**

West-Classic Tel: 0041 213 14 13 e-mail [west-classic@hotmail.com](mailto:west-classic@hotmail.com) Web: [www.west-classic.ch](http://www.west-classic.ch) / [www.west-motoren.ch](http://www.west-motoren.ch)

**ROVER**

**ROVER P5 110 1963-64**

FRONT PIPE  
CONNECTING PIPE  
SILENCER  
TAIL PIPE

BS RR 044  
BS RR 031  
BS RR 032  
BS RR 033

**SYSTEM NUMBER**

**BSS-RR-006**

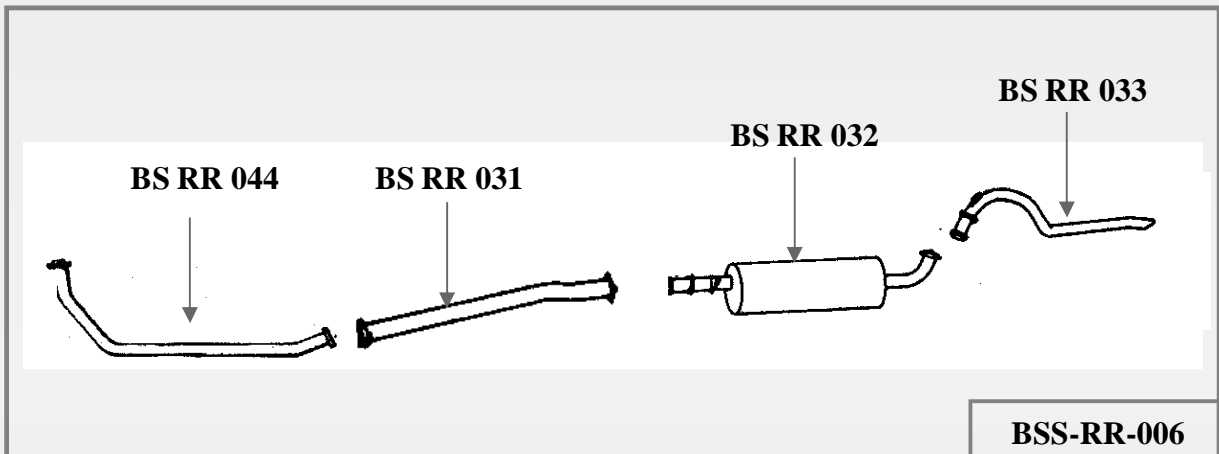



**STAINLESS STEEL EXHAUSTS**

West-Classic Tel: 0041 213 14 13 e-mail [west-classic@hotmail.com](mailto:west-classic@hotmail.com) Web: [www.west-classic.ch](http://www.west-classic.ch) / [www.west-motoren.ch](http://www.west-motoren.ch)

**ROVER**

**ROVER P5 3LTR SALOON 1959-66**

FRONT PIPE  
MAIN SILENCER ASSEMBLY  
REAR SILENCER AND TAIL PIPE

BS RR 037  
BS RR 032  
BS RR 051

**SYSTEM NUMBER**

**BSS-RR-007**

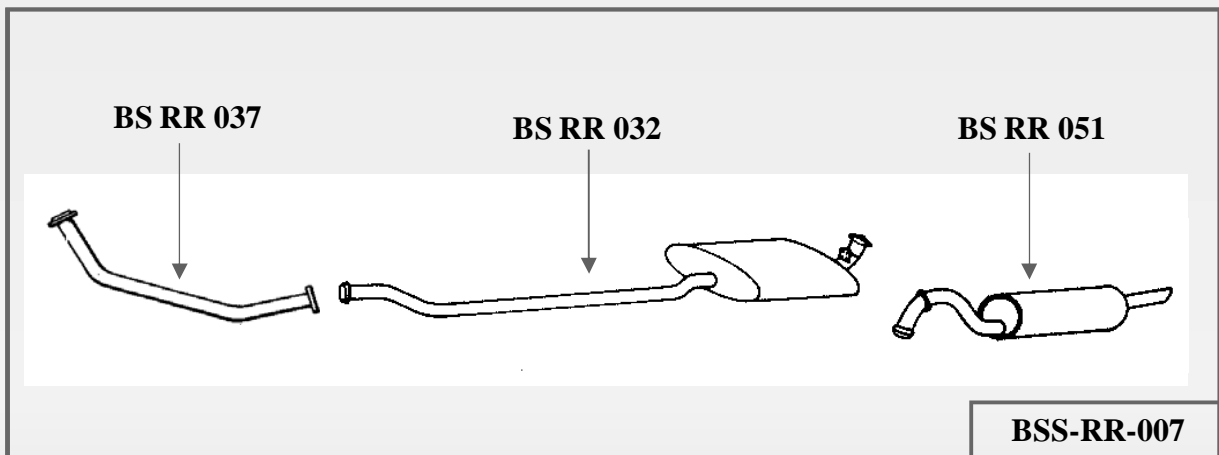



**STAINLESS STEEL EXHAUSTS**

West-Classic Tel: 0041 213 14 13 e-mail [west-classic@hotmail.com](mailto:west-classic@hotmail.com) Web: [www.west-classic.ch](http://www.west-classic.ch) / [www.west-motoren.ch](http://www.west-motoren.ch)

**ROVER**

**ROVER P5B 3.5 V8 SALOON 1967-73**

FRONT PIPE AND INTER PIPE LH	BS RR 063
FRONT PIPE RH	BS RR 064
MAIN SILENCER ASSEMBLY	BS RR 065
REAR SILENCER AND TWIN TAIL PIPES	BS RR 066

**SYSTEM NUMBER** **BSS-RR-008**

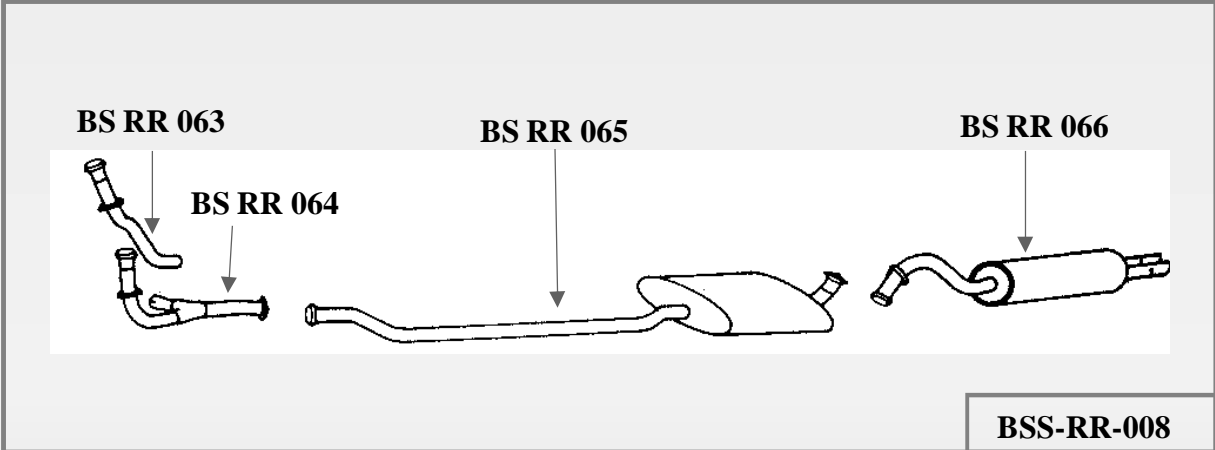



**STAINLESS STEEL EXHAUSTS**

West-Classic Tel: 0041 213 14 13 e-mail [west-classic@hotmail.com](mailto:west-classic@hotmail.com) Web: [www.west-classic.ch](http://www.west-classic.ch) / [www.west-motoren.ch](http://www.west-motoren.ch)

**ROVER**

**ROVER P6 2000 SINGLE CARB. MANUAL 2**  
**BOX SYSTEM 1966-73**

FRONT PIPE  
MAIN SILENCER ASSEMBLY  
REAR SILENCER ASSEMBLY

BS RR 058  
BS RR 069  
BS RR 070

**SYSTEM NUMBER**

**BSS-RR-009**

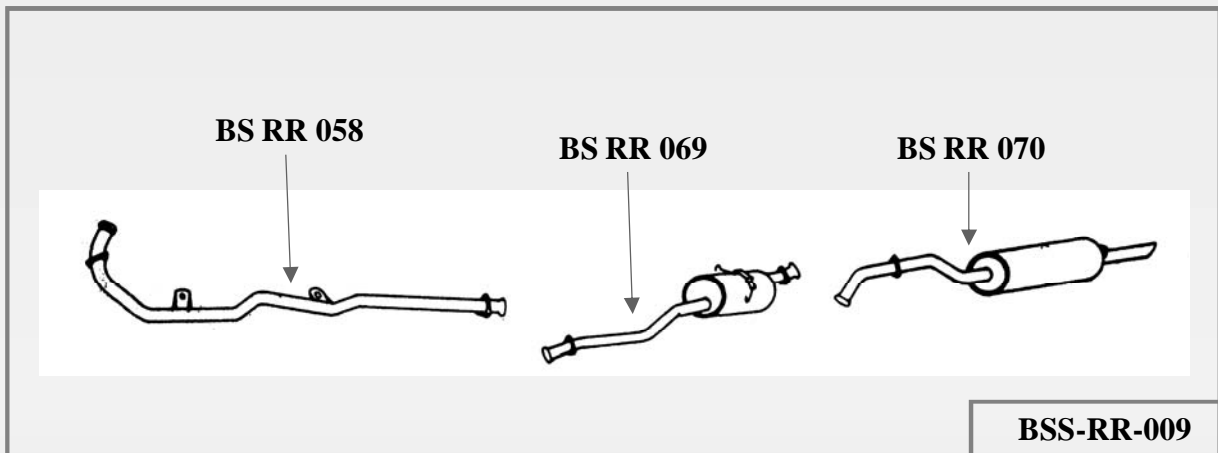



STAINLESS STEEL EXHAUSTS

West-Classic Tel: 0041 213 14 13 e-mail [west-classic@hotmail.com](mailto:west-classic@hotmail.com) Web: [www.west-classic.ch](http://www.west-classic.ch) / [www.west-motoren.ch](http://www.west-motoren.ch)

ROVER

**ROVER P6 2000 SINGLE CARB. AUTOMATIC 2 BOX**  
**SYSTEM 1966- ON**

FRONT PIPE  
MAIN SILENCER ASSEMBLY  
REAR SILENCER ASSEMBLY

BS RR 059  
BS RR 069  
BS RR 070

SYSTEM NUMBER

BSS-RR-010

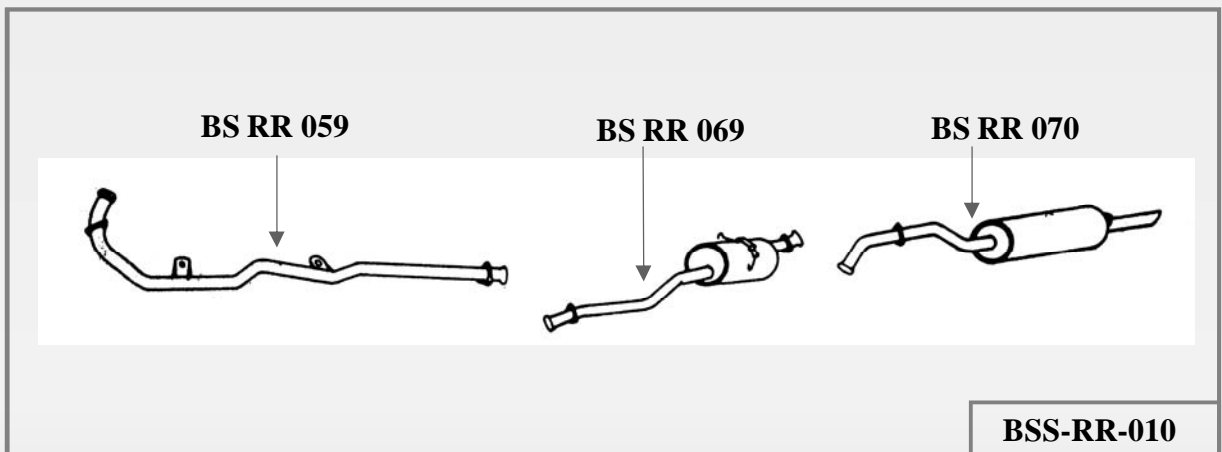



STAINLESS STEEL EXHAUSTS

West-Classic Tel: 0041 213 14 13 e-mail [west-classic@hotmail.com](mailto:west-classic@hotmail.com) Web: [www.west-classic.ch](http://www.west-classic.ch) / [www.west-motoren.ch](http://www.west-motoren.ch)

ROVER

**ROVER P6 2000 TWIN CARB. 2 BOX SYSTEM 1966- ON**

FRONT PIPE  
MAIN SILENCER ASSEMBLY  
REAR SILENCER ASSEMBLY

BS RR 062  
BS RR 069  
BS RR 070

SYSTEM NUMBER

BSS-RR-011

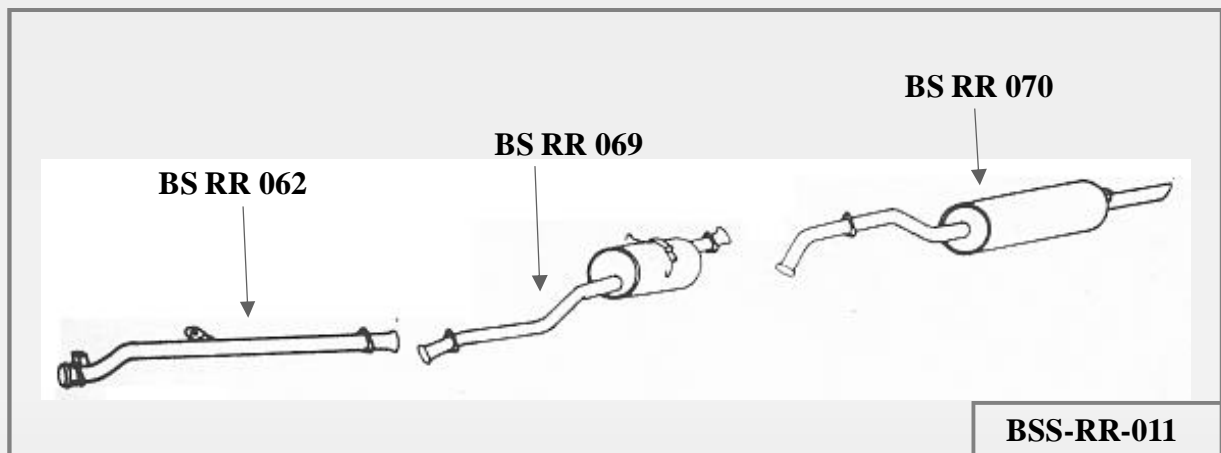



**STAINLESS STEEL EXHAUSTS**

West-Classic Tel: 0041 213 14 13 e-mail [west-classic@hotmail.com](mailto:west-classic@hotmail.com) Web: [www.west-classic.ch](http://www.west-classic.ch) / [www.west-motoren.ch](http://www.west-motoren.ch)

**ROVER**

**ROVER P6 2000 2200 TWIN CARB. 3 BOX SYSTEM**  
**1973- ON**

FRONT PIPE	BS RR 082
FRONT SILENCER	BS RR 075
MAIN SILENCER ASSEMBLY	BS RR 069
REAR SILENCER ASSEMBLY	BS RR 070

**SYSTEM NUMBER**

**BSS-RR-012**

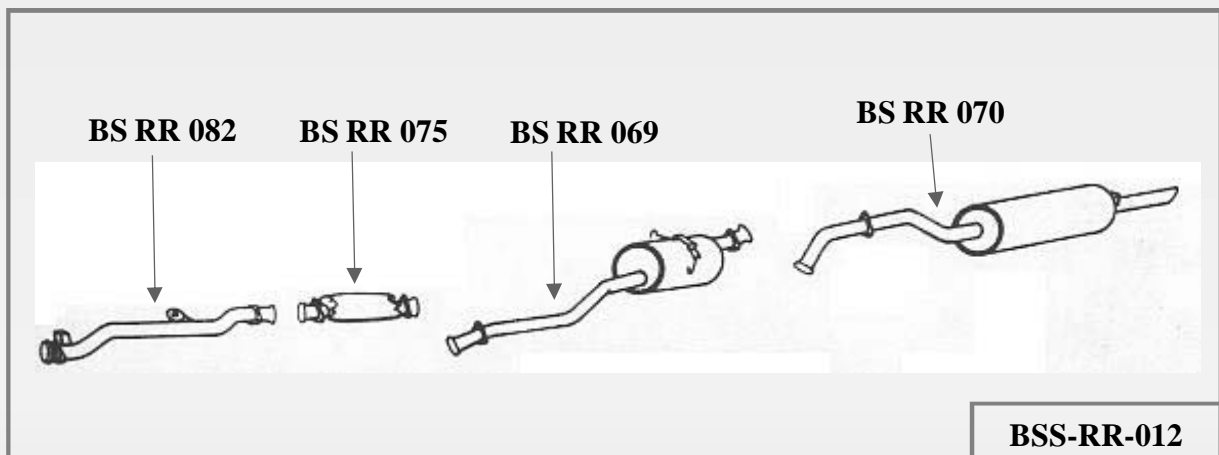





**STAINLESS STEEL EXHAUSTS**

West-Classic Tel: 0041 213 14 13 e-mail [west-classic@hotmail.com](mailto:west-classic@hotmail.com) Web: [www.west-classic.ch](http://www.west-classic.ch) / [www.west-motoren.ch](http://www.west-motoren.ch)

**ROVER**

**ROVER P6 2000 SINGLE CARB. 3 BOX SYSTEM 1973- 77**

FRONT PIPE  
FRONT SILENCER  
MAIN SILENCER ASSEMBLY  
REAR SILENCER ASSEMBLY

BS RR 073  
BS RR 075  
BS RR 069  
BS RR 070

**SYSTEM NUMBER**

**BSS-RR-013**

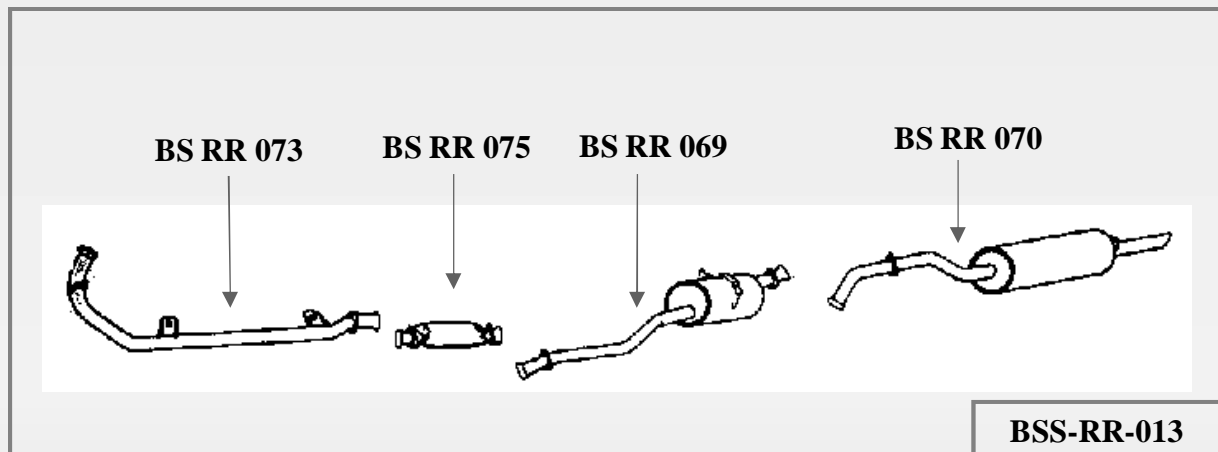



STAINLESS STEEL EXHAUSTS

West-Classic Tel: 0041 213 14 13 e-mail [west-classic@hotmail.com](mailto:west-classic@hotmail.com) Web: [www.west-classic.ch](http://www.west-classic.ch) / [www.west-motoren.ch](http://www.west-motoren.ch)

ROVER

**ROVER P6 2000 SINGLE CARB. AUTOMATIC 3 BOX**  
**SYSTEM 1973- 77**

FRONT PIPE  
FRONT SILENCER  
MAIN SILENCER ASSEMBLY  
REAR SILENCER ASSEMBLY

BS RR 081  
BS RR 075  
BS RR 069  
BS RR 070

SYSTEM NUMBER

BSS-RR-014

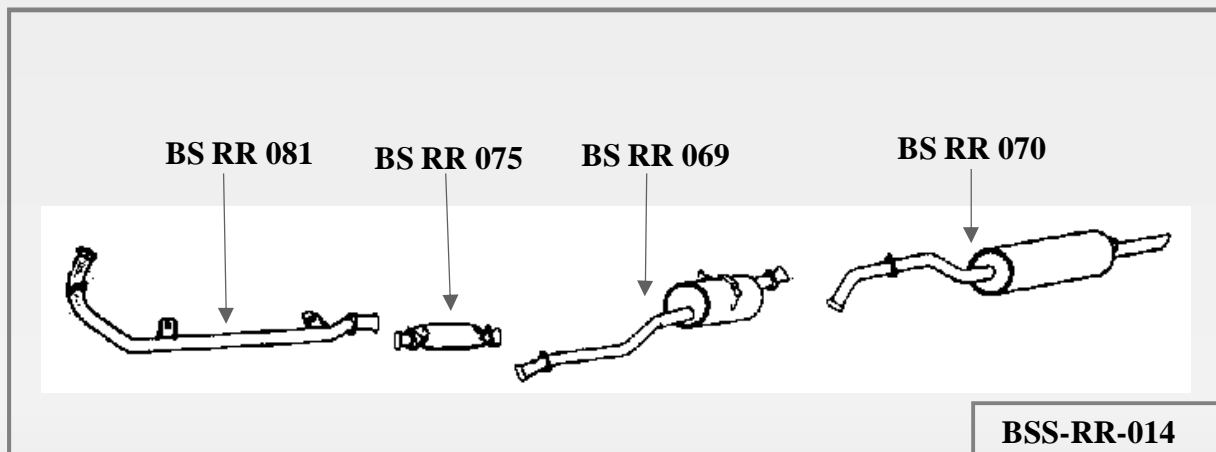



**STAINLESS STEEL EXHAUSTS**

West-Classic Tel: 0041 213 14 13 e-mail [west-classic@hotmail.com](mailto:west-classic@hotmail.com) Web: [www.west-classic.ch](http://www.west-classic.ch) / [www.west-motoren.ch](http://www.west-motoren.ch)

**ROVER**

**ROVER P6 3500S MANUAL 1971-76**

3500S LH FRONT PIPE  
3500S RH FRONT PIPE  
3500S D/E CHASSIS BIG BORE  
3500S D/E CHASSIS BIG BORE

BS RR 077  
BS RR 078  
BS RR 079  
BS RR 080

**SYSTEM NUMBER**

**BSS-RR-016**

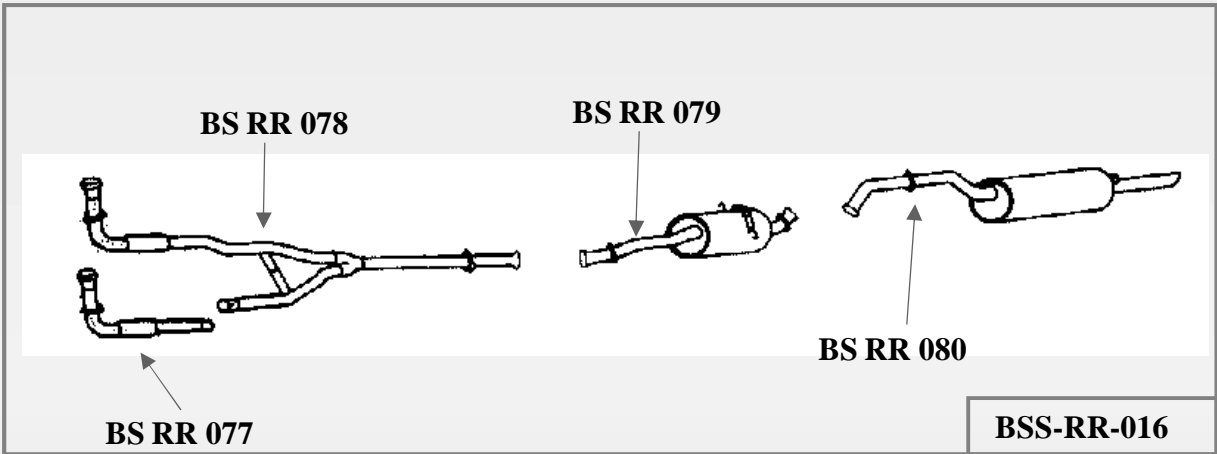



STAINLESS STEEL EXHAUSTS

West-Classic Tel: 0041 213 14 13 e-mail [west-classic@hotmail.com](mailto:west-classic@hotmail.com) Web: [www.west-classic.ch](http://www.west-classic.ch) / [www.west-motoren.ch](http://www.west-motoren.ch)

ROVER

**ROVER P6 3500 AUTOMATIC CHASSIS D**

P6 RH FRONT PIPE  
P6 LH FRONT PIPE  
MAIN SILENCER ASSEMBLY  
REAR SILENCER ASSEMBLY

BS RR 067  
BS RR 068  
BS RR 066  
BS RR 070

**SYSTEM NUMBER**

**BSS-RR-018**

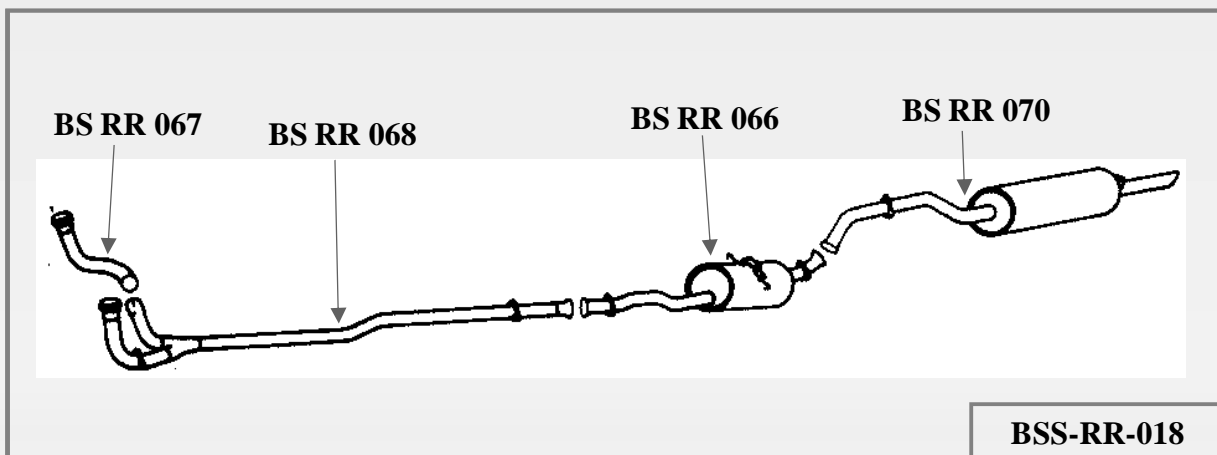



**STAINLESS STEEL EXHAUSTS**

West-Classic Tel: 0041 213 14 13 e-mail [west-classic@hotmail.com](mailto:west-classic@hotmail.com) Web: [www.west-classic.ch](http://www.west-classic.ch) / [www.west-motoren.ch](http://www.west-motoren.ch)

**ROVER**

**ROVER P6 3500 AUTOMATIC CHASSIS E**

P6 RH FRONT PIPE  
P6 LH FRONT PIPE  
3500S D/E CHASSIS BIG BORE  
3500S D/E CHASSIS BIG BORE

BS RR 067  
BS RR 084  
BS RR 079  
BS RR 080

**SYSTEM NUMBER**

**BSS-RR-019**

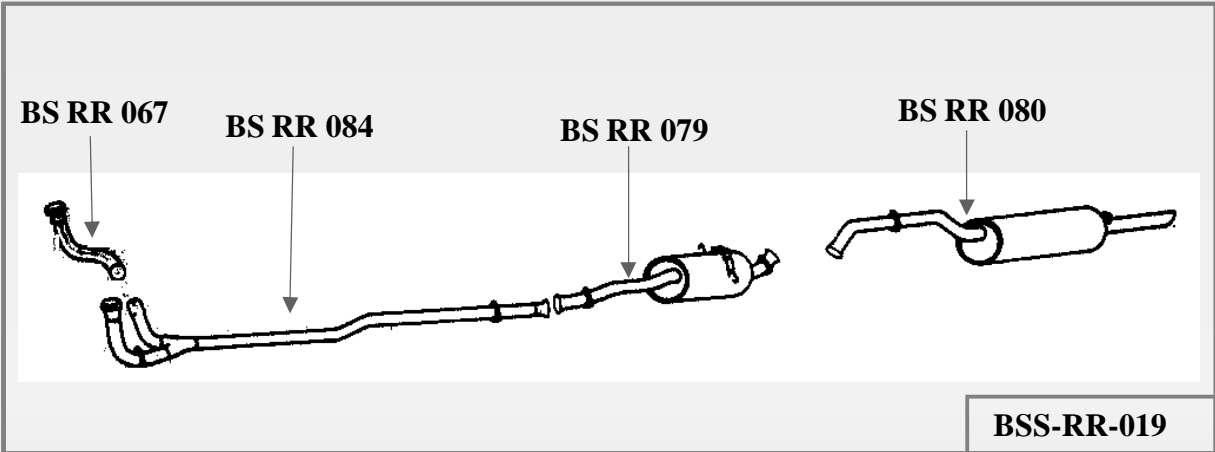



**STAINLESS STEEL EXHAUSTS**

West-Classic Tel: 0041 213 14 13 e-mail [west-classic@hotmail.com](mailto:west-classic@hotmail.com) Web: [www.west-classic.ch](http://www.west-classic.ch) / [www.west-motoren.ch](http://www.west-motoren.ch)

**TRIUMPH**

**HERALD 1200 1964-ON**

FRONT PIPE FRONT  
FRONT PIPE REAR  
SILENCER AND TAIL PIPE

BS TH 029A  
BS TH 029B  
BS TH 031

**SYSTEM NUMBER**

**BSS-TH-001**

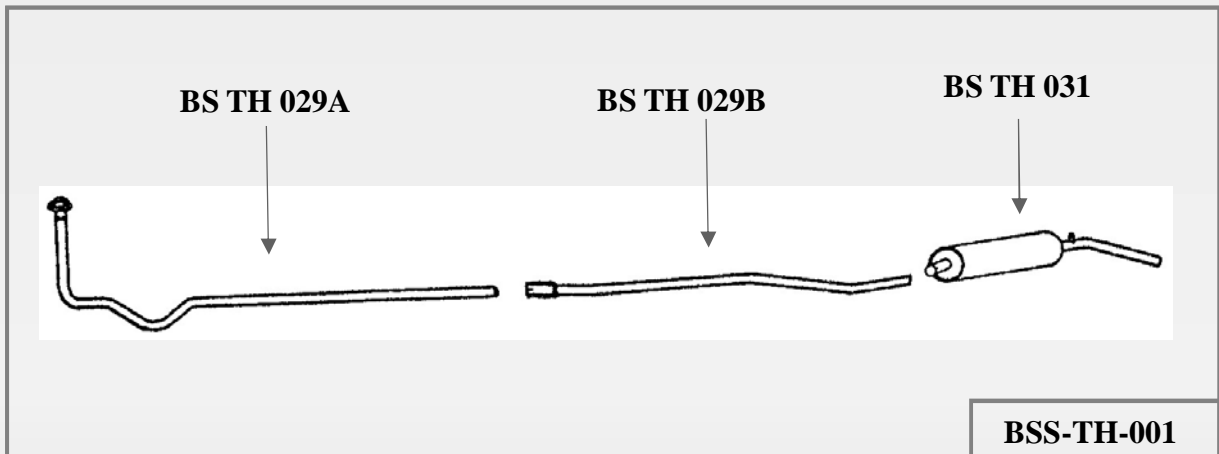



**STAINLESS STEEL EXHAUSTS**

West-Classic Tel: 0041 213 14 13 e-mail [west-classic@hotmail.com](mailto:west-classic@hotmail.com) Web: [www.west-classic.ch](http://www.west-classic.ch) / [www.west-motoren.ch](http://www.west-motoren.ch)

**TRIUMPH**

**HERALD 12/50 1964-ON**

FRONT PIPE FRONT  
FRONT PIPE REAR  
SILENCER AND TAIL PIPE

BS TH 030A  
BS TH 030B  
BS TH 031

**SYSTEM NUMBER**

**BSS-TH-002**

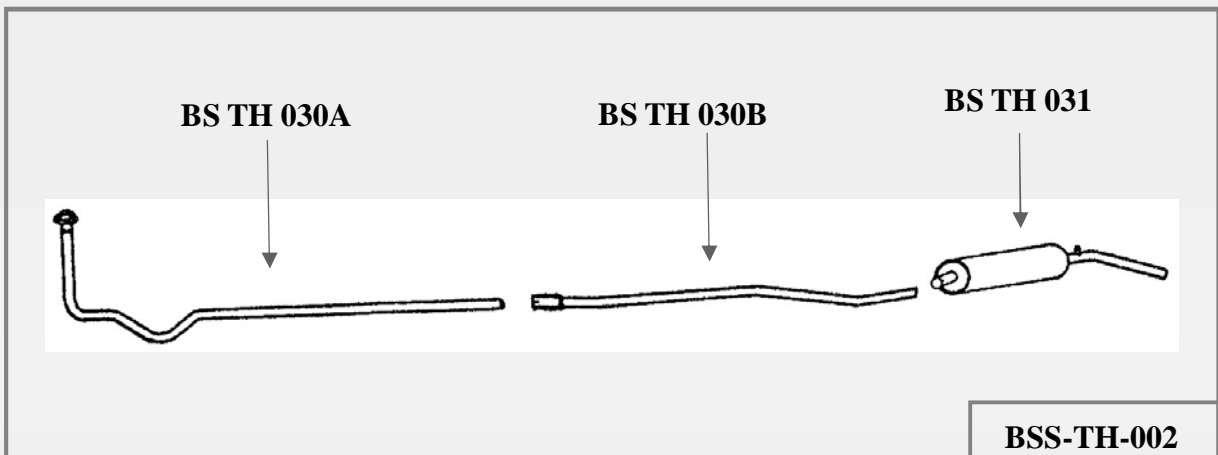

# BELL

## STAINLESS STEEL EXHAUSTS

West-Classic Tel: 0041 213 14 13 e-mail [west-classic@hotmail.com](mailto:west-classic@hotmail.com) Web: [www.west-classic.ch](http://www.west-classic.ch) / [www.west-motoren.ch](http://www.west-motoren.ch)

## TRIUMPH

### HERALD 13/60 1962-65

FRONT PIPE FRONT  
FRONT PIPE REAR  
SILENCER AND TAIL PIPE

BS TH 075A  
BS TH 075B  
BS TH 031

SYSTEM NUMBER

**BSS-TH-003**

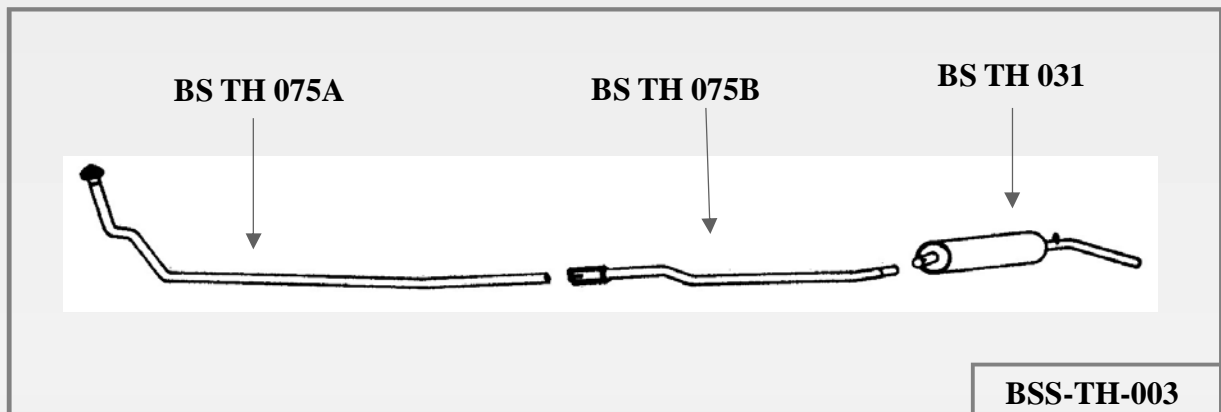





**STAINLESS STEEL EXHAUSTS**

West-Classic Tel: 0041 213 14 13 e-mail [west-classic@hotmail.com](mailto:west-classic@hotmail.com) Web: [www.west-classic.ch](http://www.west-classic.ch) / [www.west-motoren.ch](http://www.west-motoren.ch)

**TRIUMPH**

**VITESSE 1600 MKI 1962-65**

FRONT PIPE

BS TH 061

FRONT PIPE REAR SECTION

BS TH 032

SILENCER AND TAIL PIPE

BS TH 033

**SYSTEM NUMBER**

**BSS-TH-004**

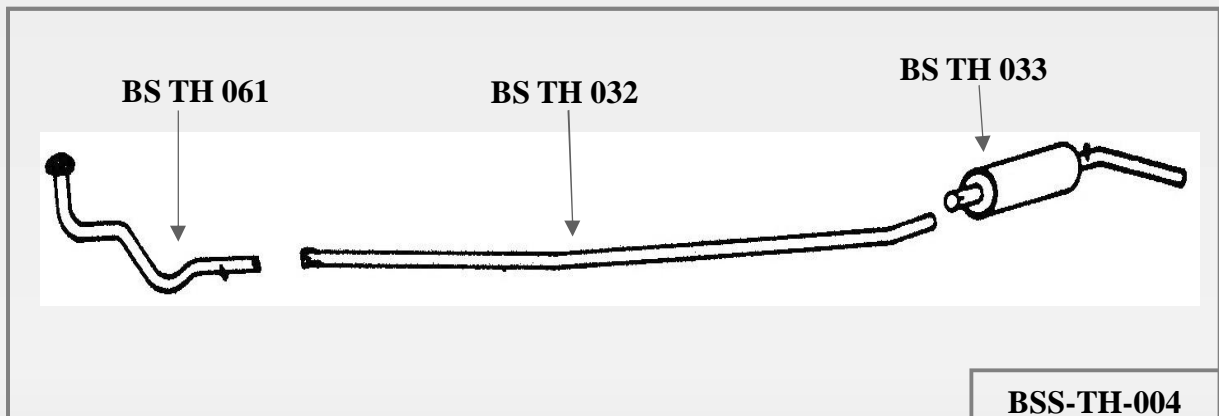



**STAINLESS STEEL EXHAUSTS**

West-Classic Tel: 0041 213 14 13 e-mail [west-classic@hotmail.com](mailto:west-classic@hotmail.com) Web: [www.west-classic.ch](http://www.west-classic.ch) / [www.west-motoren.ch](http://www.west-motoren.ch)

**TRIUMPH**

**VITESSE 2000 MKI TWO BOX SYSTEM 1966-68**

FRONT PIPE	BS TH 058
MIDDLE SILENCER	BS TH 059
REAR SILENCER	BS TH 060

**SYSTEM NUMBER BSS-TH-005**

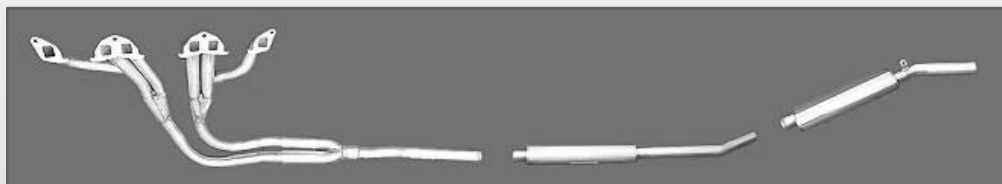
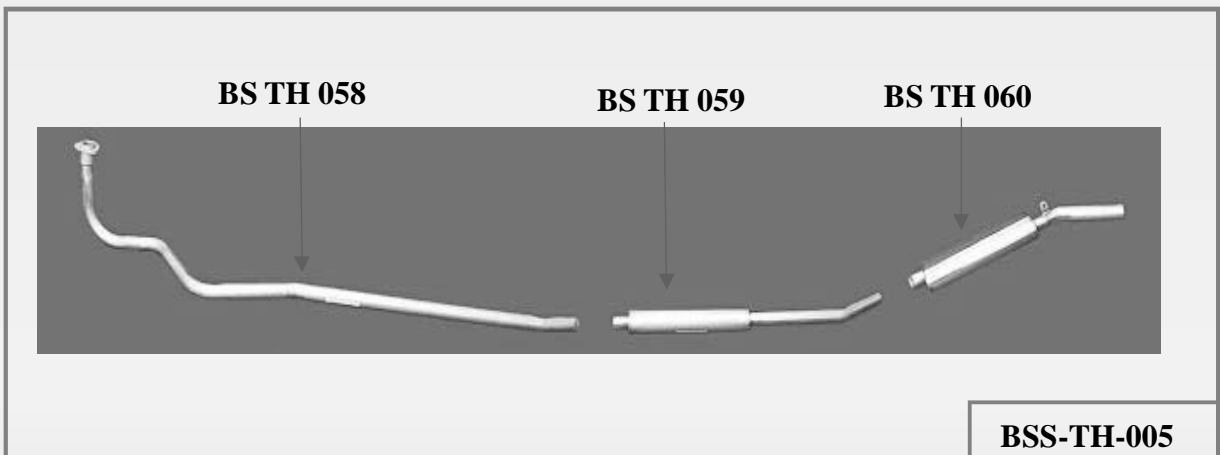

**Above picture showing manifold which is available as an extra if required part no. BS TH**





**STAINLESS STEEL EXHAUSTS**

West-Classic Tel: 0041 213 14 13 e-mail [west-classic@hotmail.com](mailto:west-classic@hotmail.com) Web: [www.west-classic.ch](http://www.west-classic.ch) / [www.west-motoren.ch](http://www.west-motoren.ch)

**TRIUMPH**

**VITESSE 2000 MKII ONE BOX SYSTEM 1968-71**

FRONT PIPE  
LINK PIPE NEW STYLE  
REAR SILENCER

BS TH 123  
BS TH 080  
BS TH 081

**SYSTEM NUMBER**

**BSS-TH-006**

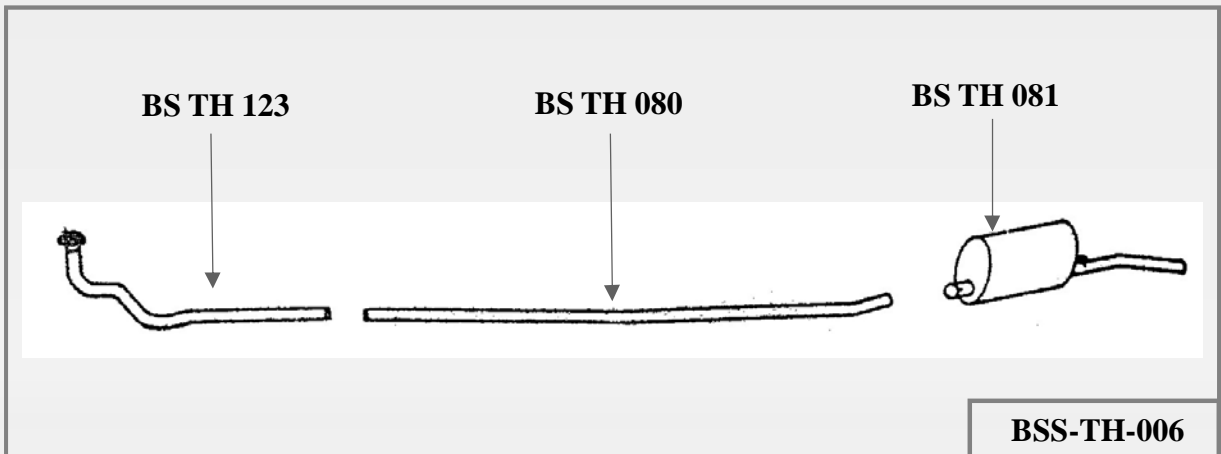



**STAINLESS STEEL EXHAUSTS**

West-Classic Tel: 0041 213 14 13 e-mail [west-classic@hotmail.com](mailto:west-classic@hotmail.com) Web: [www.west-classic.ch](http://www.west-classic.ch) / [www.west-motoren.ch](http://www.west-motoren.ch)

**TRIUMPH**

**SPITFIRE MKI 1962-65**

FRONT PIPE  
MIDDLE SILENCER  
LINK PIPE  
REAR SILENCER

BS TH 034  
BS TH 035  
BS TH 036  
BS TH 037

**SYSTEM NUMBER**

**BSS-TH-007**

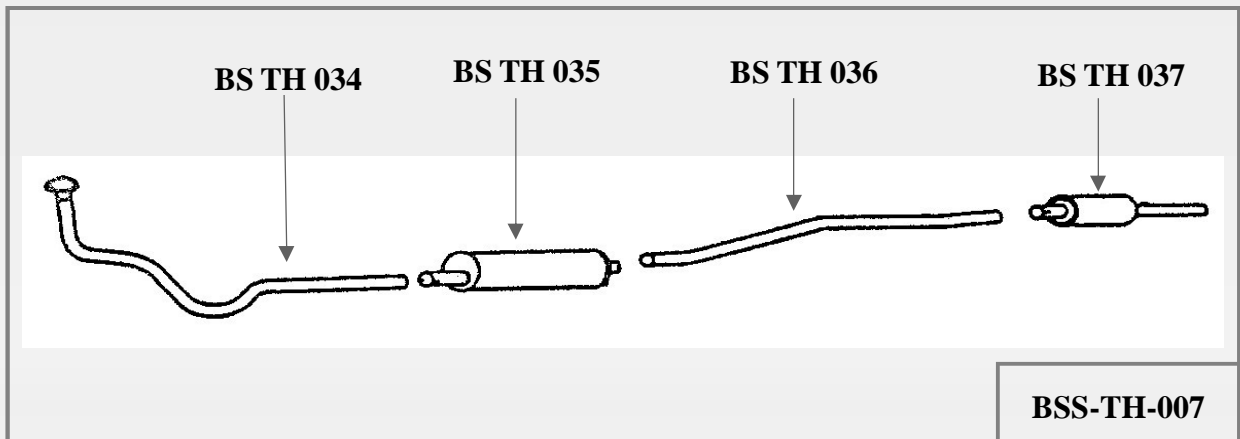



**STAINLESS STEEL EXHAUSTS**

West-Classic Tel: 0041 213 14 13 e-mail [west-classic@hotmail.com](mailto:west-classic@hotmail.com) Web: [www.west-classic.ch](http://www.west-classic.ch) / [www.west-motoren.ch](http://www.west-motoren.ch)

**TRIUMPH**

**SPITFIRE MKII 1965-67**

MIDDLE SILENCER  
LINK PIPE  
REAR SILENCER

BS TH 035  
BS TH 036  
BS TH 037

**SYSTEM NUMBER**

**BSS-TH-008**

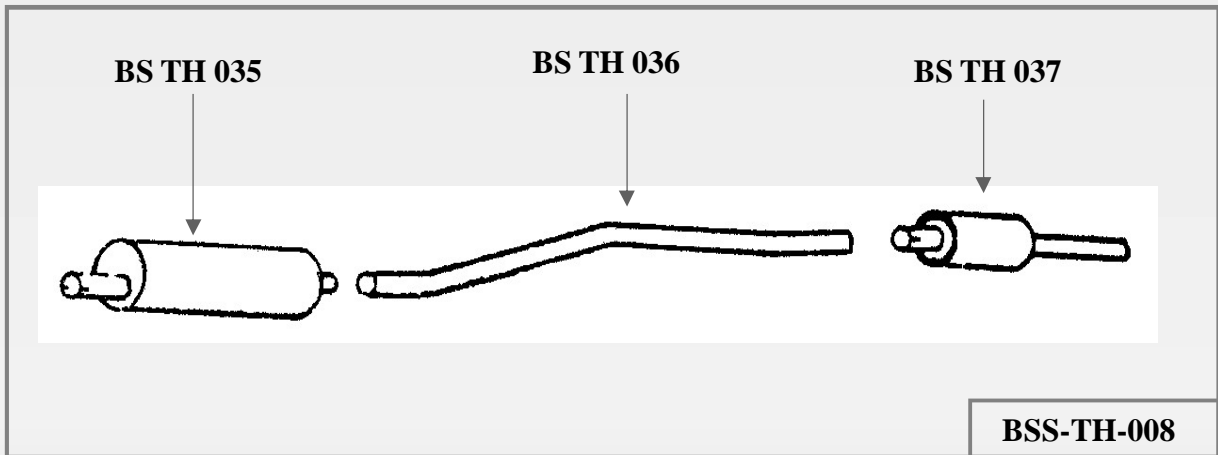



**STAINLESS STEEL EXHAUSTS**

West-Classic Tel: 0041 213 14 13 e-mail [west-classic@hotmail.com](mailto:west-classic@hotmail.com) Web: [www.west-classic.ch](http://www.west-classic.ch) / [www.west-motoren.ch](http://www.west-motoren.ch)

**TRIUMPH**

**SPITFIRE MKIII 1967-70**

FRONT PIPE  
MIDDLE SILNECER  
REAR SILENCER

BS TH 066  
BS TH 062  
BS TH 067

**SYSTEM NUMBER**

**BSS-TH-009**

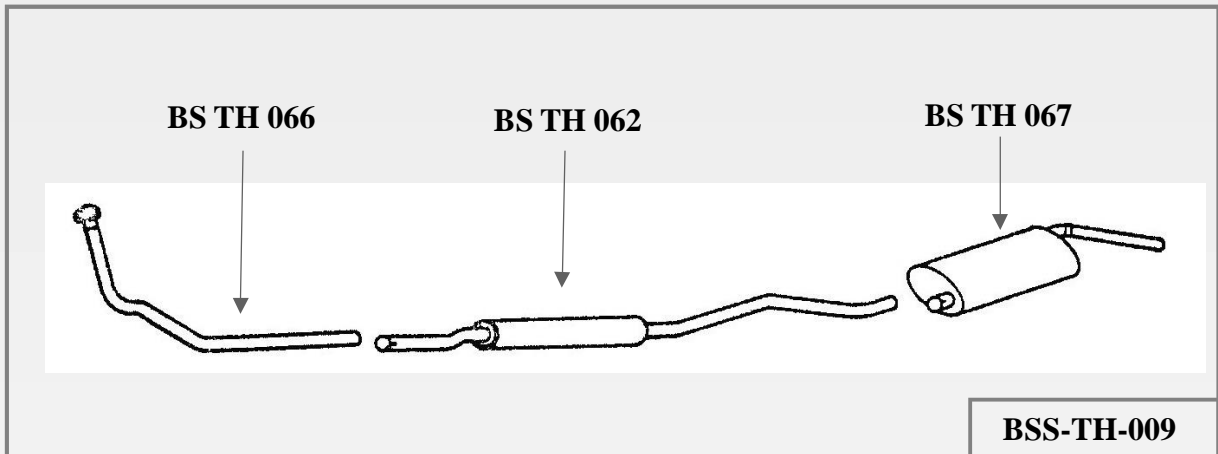



**STAINLESS STEEL EXHAUSTS**

West-Classic Tel: 0041 213 14 13 e-mail [west-classic@hotmail.com](mailto:west-classic@hotmail.com) Web: [www.west-classic.ch](http://www.west-classic.ch) / [www.west-motoren.ch](http://www.west-motoren.ch)

**TRIUMPH**

**SPITFIRE MKIV 1967-70**

FRONT PIPE

REAR FRONT PIPE MKIV SPITE

REAR SILENCER

BS TH 066

BS TH 121

BS TH 150

**SYSTEM NUMBER**

**BSS-TH-010**

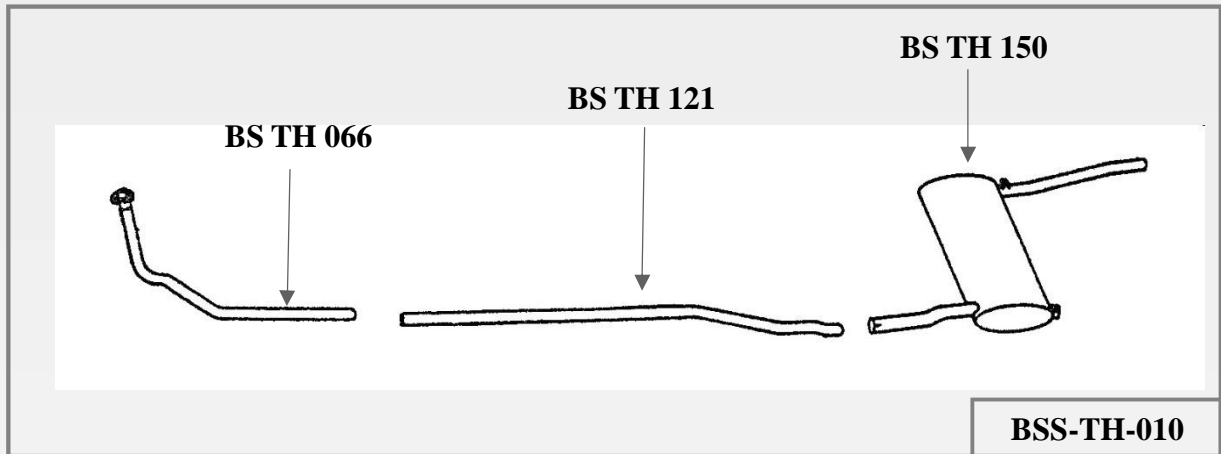



**STAINLESS STEEL EXHAUSTS**

West-Classic Tel: 0041 213 14 13 e-mail [west-classic@hotmail.com](mailto:west-classic@hotmail.com) Web: [www.west-classic.ch](http://www.west-classic.ch) / [www.west-motoren.ch](http://www.west-motoren.ch)

**TRIUMPH**

**SPITFIRE MKV 1500 1975-ON**

TWIN FRONT PIPE  
LINK PIPE  
REAR SILENCER

BS TH 148  
BS TH 149  
BS TH 150

**SYSTEM NUMBER**

**BSS-TH-011**

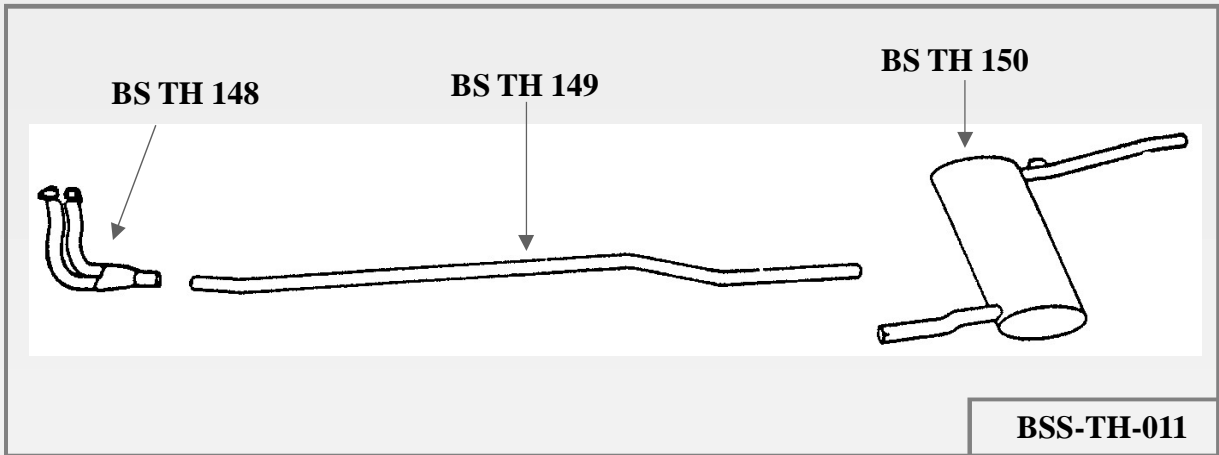





**STAINLESS STEEL EXHAUSTS**

West-Classic Tel: 0041 213 14 13 e-mail [west-classic@hotmail.com](mailto:west-classic@hotmail.com) Web: [www.west-classic.ch](http://www.west-classic.ch) / [www.west-motoren.ch](http://www.west-motoren.ch)

**TRIUMPH**

**GT6 MKI 1966-68**

FRONT PIPE

LINK PIPE

REAR SILENCER

BS TH 061

BS TH 062

BS TH 063

**SYSTEM NUMBER**

**BSS-TH-012**

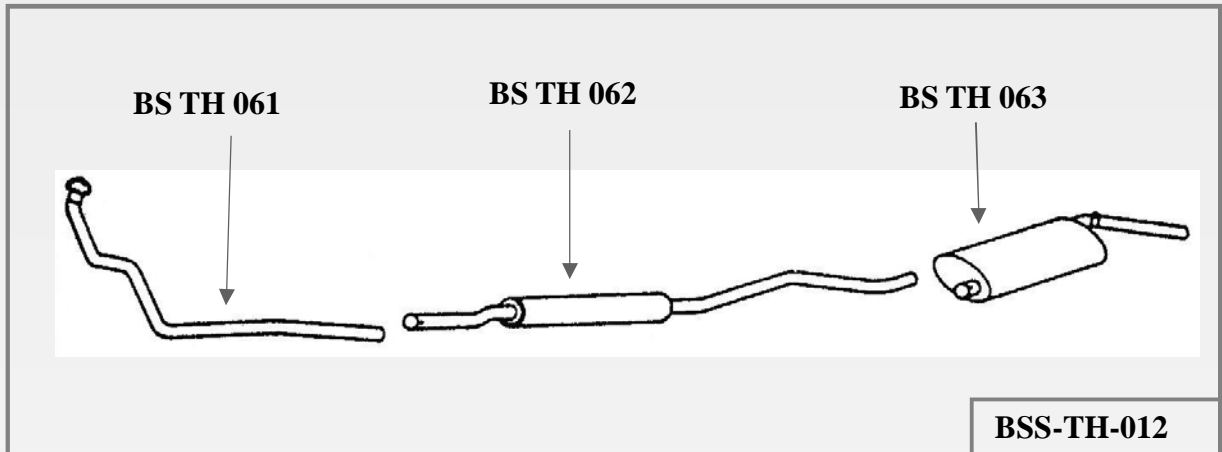

# BELL

## STAINLESS STEEL EXHAUSTS

West-Classic Tel: 0041 213 14 13 e-mail [west-classic@hotmail.com](mailto:west-classic@hotmail.com) Web: [www.west-classic.ch](http://www.west-classic.ch) / [www.west-motoren.ch](http://www.west-motoren.ch)

## TRIUMPH

### GT6 MKII 1968-70

FRONT PIPE

LINK PIPE

REAR SILENCER

BS TH 123

BS TH 087

BS TH 088

**SYSTEM NUMBER**

**BSS-TH-013**

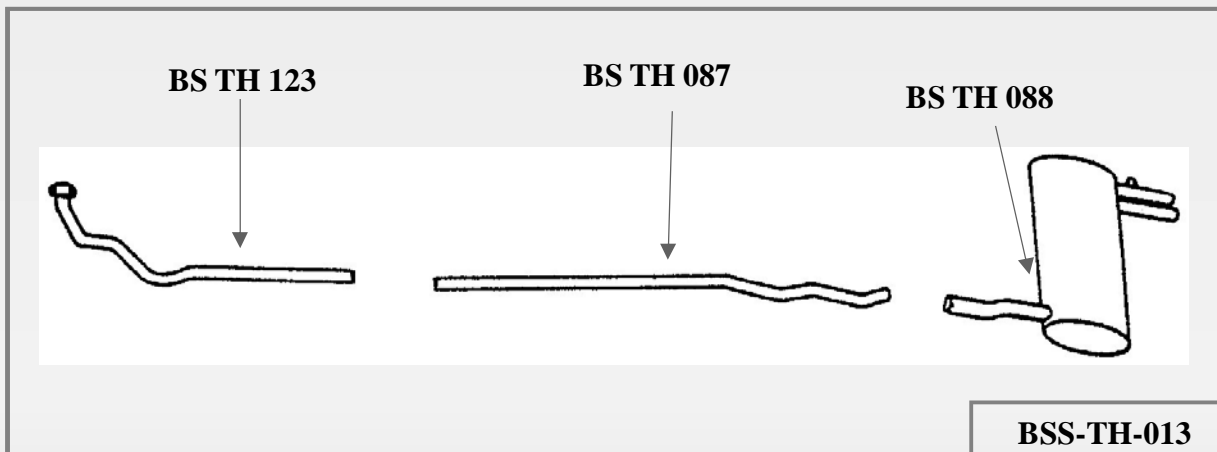



**STAINLESS STEEL EXHAUSTS**

West-Classic Tel: 0041 213 14 13 e-mail [west-classic@hotmail.com](mailto:west-classic@hotmail.com) Web: [www.west-classic.ch](http://www.west-classic.ch) / [www.west-motoren.ch](http://www.west-motoren.ch)

**TRIUMPH**

**GT6 MKIII 1970-74**

FRONT PIPE  
MIDDLE SILENCER  
REAR SILENCER

BS TH 123  
BS TH 130  
BS TH 124

**SYSTEM NUMBER**

**BSS-TH-014**

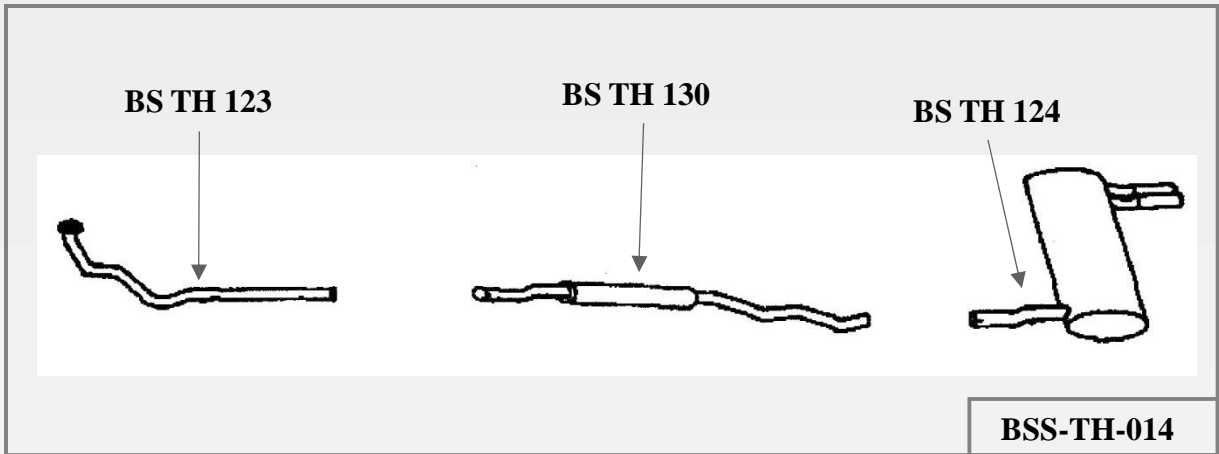

# BELL

## STAINLESS STEEL EXHAUSTS

West-Classic Tel: 0041 213 14 13 e-mail [west-classic@hotmail.com](mailto:west-classic@hotmail.com) Web: [www.west-classic.ch](http://www.west-classic.ch) / [www.west-motoren.ch](http://www.west-motoren.ch)

## TRIUMPH

### TR2/TR3/TRA/TR4 – 1956-65

FRONT PIPE  
SILENCER  
REAR SILENCER

BS TH 020  
BS TH 021  
BS TH 028

**SYSTEM NUMBER**

**BSS-TH-015**

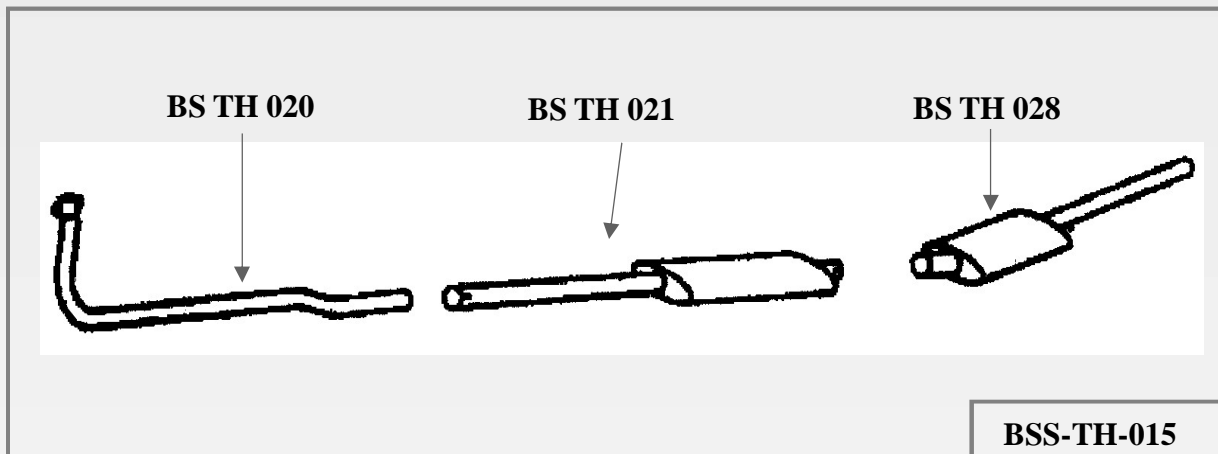



**STAINLESS STEEL EXHAUSTS**

West-Classic Tel: 0041 213 14 13 e-mail [west-classic@hotmail.com](mailto:west-classic@hotmail.com) Web: [www.west-classic.ch](http://www.west-classic.ch) / [www.west-motoren.ch](http://www.west-motoren.ch)

**TRIUMPH**

**TR4A TWIN – 1965-66**

TWIN FRONT PIPE

SILENCER

“Y” PIECE

SILENCER AND TAIL PIPE RH

SILENCER AND TAIL PIPE LH

BS TH 047

BS TH 048

BS TH 054

BS TH 049

BS TH 050

**SYSTEM NUMBER**

**BSS-TH-016**

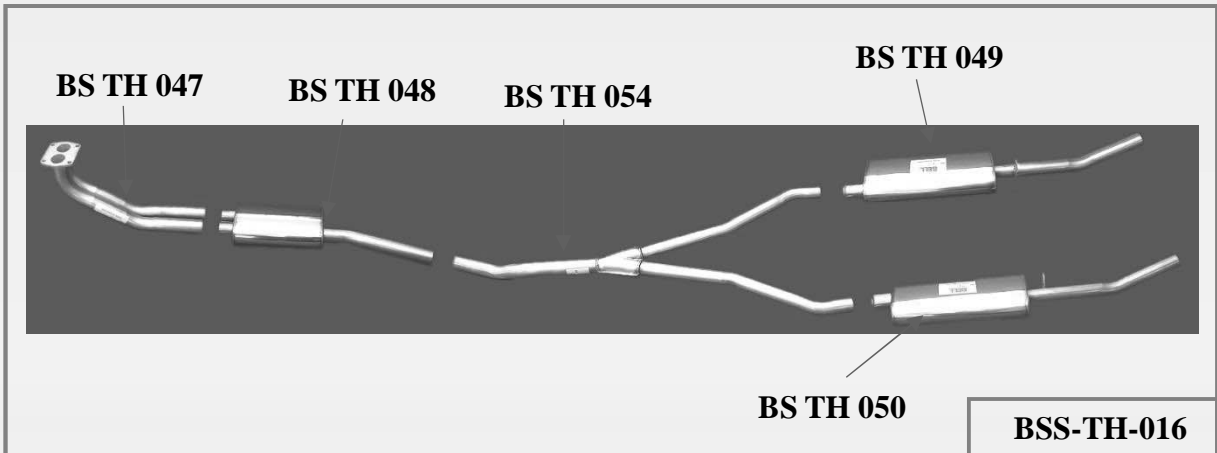



**STAINLESS STEEL EXHAUSTS**

West-Classic Tel: 0041 213 14 13 e-mail [west-classic@hotmail.com](mailto:west-classic@hotmail.com) Web: [www.west-classic.ch](http://www.west-classic.ch) / [www.west-motoren.ch](http://www.west-motoren.ch)

**TRIUMPH**

**TR4A IRS 1966-67**

TWIN FRONT PIPE  
“Y” PIECE  
LINK PIPE  
SILENCER AND TAIL PIPE LH

BS TH 047  
BS TH 056  
BS TH 055  
BS TH 057

**SYSTEM NUMBER**

**BSS-TH-017**

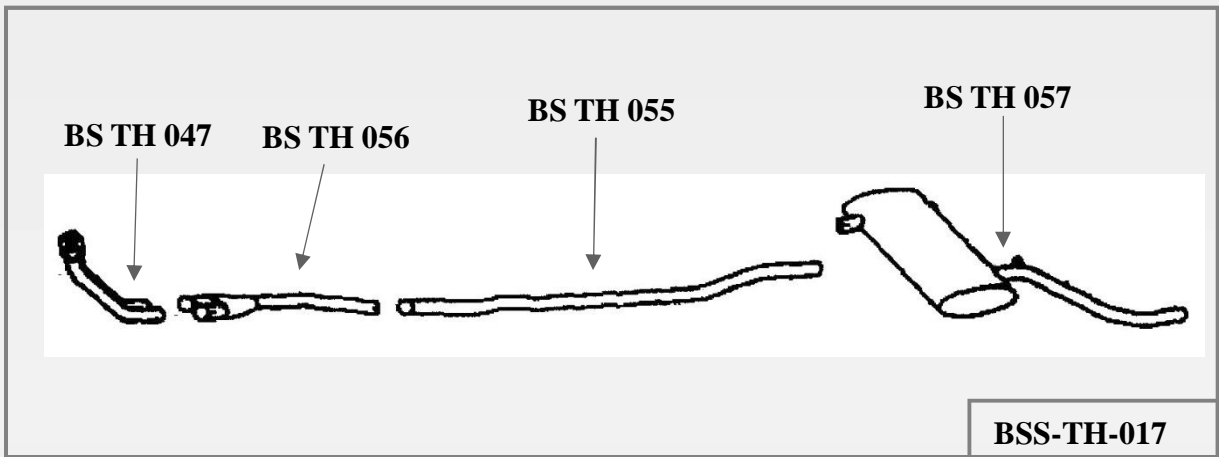



**STAINLESS STEEL EXHAUSTS**

West-Classic Tel: 0041 213 14 13 e-mail [west-classic@hotmail.com](mailto:west-classic@hotmail.com) Web: [www.west-classic.ch](http://www.west-classic.ch) / [www.west-motoren.ch](http://www.west-motoren.ch)

**TRIUMPH**

**TR4A IRS 1966-67**

TWIN FRONT PIPE  
FRONT LINK PIPE OUTER  
FRONT LINK PIPE INNER  
REAR LINK PIPE  
REAR LINK PIPE  
REAR SILENCER

BS TH 047  
BS TH 076  
BS TH 077  
BS TH 074  
BS TH 074  
BS TH 102

**SYSTEM NUMBER**

**BSS-TH-018**

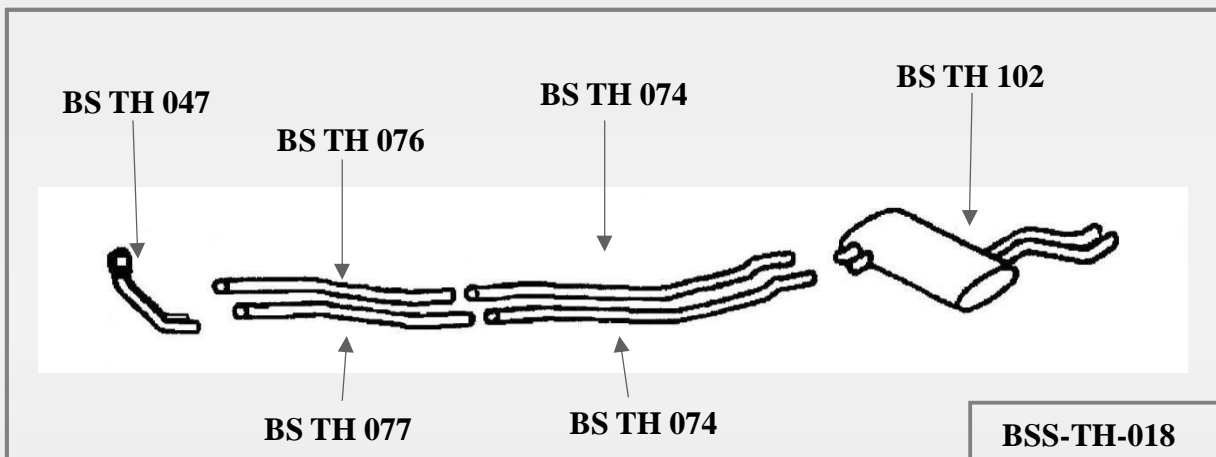



**STAINLESS STEEL EXHAUSTS**

West-Classic Tel: 0041 213 14 13 e-mail [west-classic@hotmail.com](mailto:west-classic@hotmail.com) Web: [www.west-classic.ch](http://www.west-classic.ch) / [www.west-motoren.ch](http://www.west-motoren.ch)

**TRIUMPH**

**TR CARBURETTOR 250 1967-75**

FRONT PIPE TR250  
INTERPIPE  
SILENCER TR250

BS TH 071  
BS TH 055  
BS TH 079

**SYSTEM NUMBER**

**BSS-TH-019**

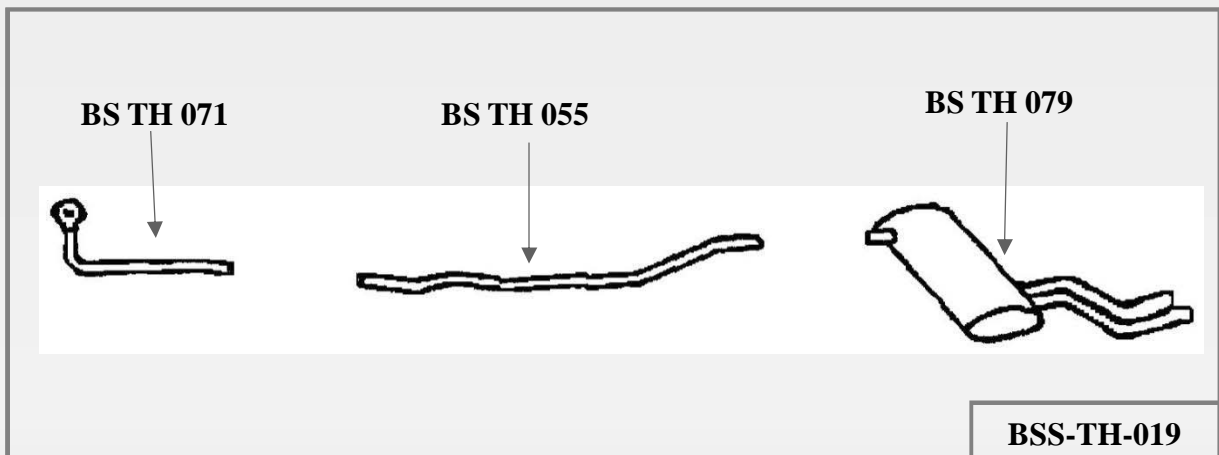





STAINLESS STEEL EXHAUSTS

West-Classic Tel: 0041 213 14 13 e-mail [west-classic@hotmail.com](mailto:west-classic@hotmail.com) Web: [www.west-classic.ch](http://www.west-classic.ch) / [www.west-motoren.ch](http://www.west-motoren.ch)

TRIUMPH

**TR CARBURETTOR 1967-75**

FRONT PIPE TR250  
INTERPIPE  
SILENCER TR250

BS TH 071  
BS TH 055  
BS TH 079

**SYSTEM NUMBER**

**BSS-TH-020**

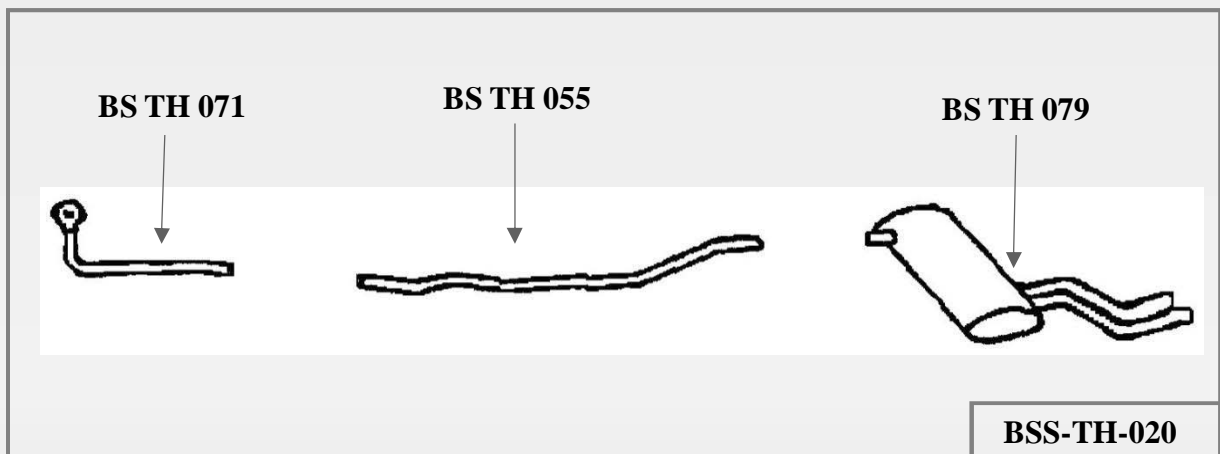



**STAINLESS STEEL EXHAUSTS**

West-Classic Tel: 0041 213 14 13 e-mail [west-classic@hotmail.com](mailto:west-classic@hotmail.com) Web: [www.west-classic.ch](http://www.west-classic.ch) / [www.west-motoren.ch](http://www.west-motoren.ch)

**TRIUMPH**

**TR6 SPORTS SYSTEM 1967-75**

- |                                 |            |
|---------------------------------|------------|
| TWIN FRONT PIPE                 | BS TH 047  |
| FRONT LINK PIPE OUTER           | BS TH 076  |
| FRONT LINK PIPE INNER           | BS TH 077  |
| REAR LINK PIPE                  | BS TH 074  |
| TR5/6 LEFT HAND SPORT LINK PIPE | BS TH 074M |
| RIGHT HAND REAR BOX SPORT       | BS TH 249  |
| LEFT HAND REAR BOX SPORT        | BS TH 250  |

**SYSTEM NUMBER**

**BSS-TH-021**

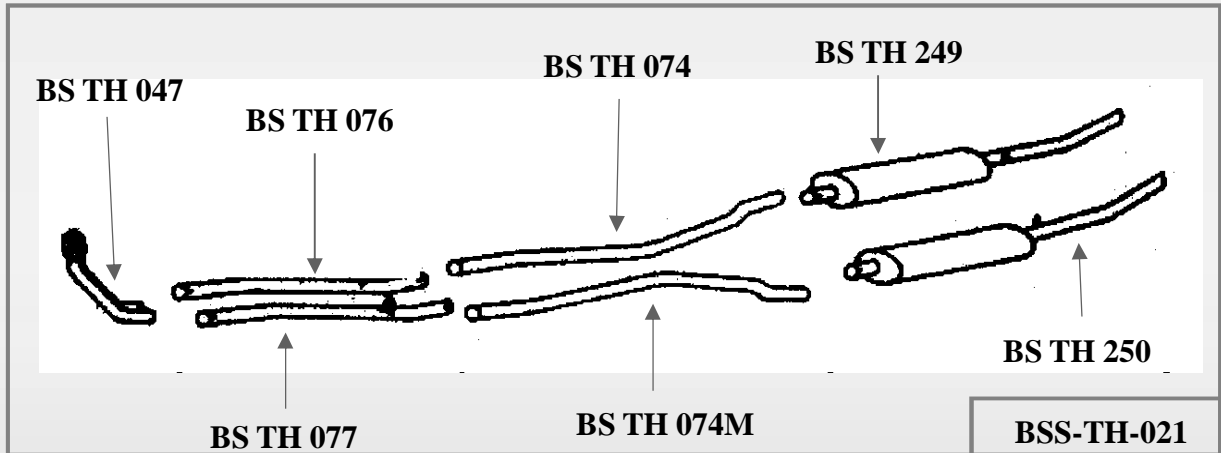



**STAINLESS STEEL EXHAUSTS**

West-Classic Tel: 0041 213 14 13 e-mail [west-classic@hotmail.com](mailto:west-classic@hotmail.com) Web: [www.west-classic.ch](http://www.west-classic.ch) / [www.west-motoren.ch](http://www.west-motoren.ch)

**TRIUMPH**

**TR6 SPORTS SYSTEM 1967-75**

FRONT PIPE  
MID BOX TR7  
SILENCER AND TAIL PIPE

BS TH 156  
BS TH 157  
BS TH 175

**SYSTEM NUMBER**

**BSS-TH-022**

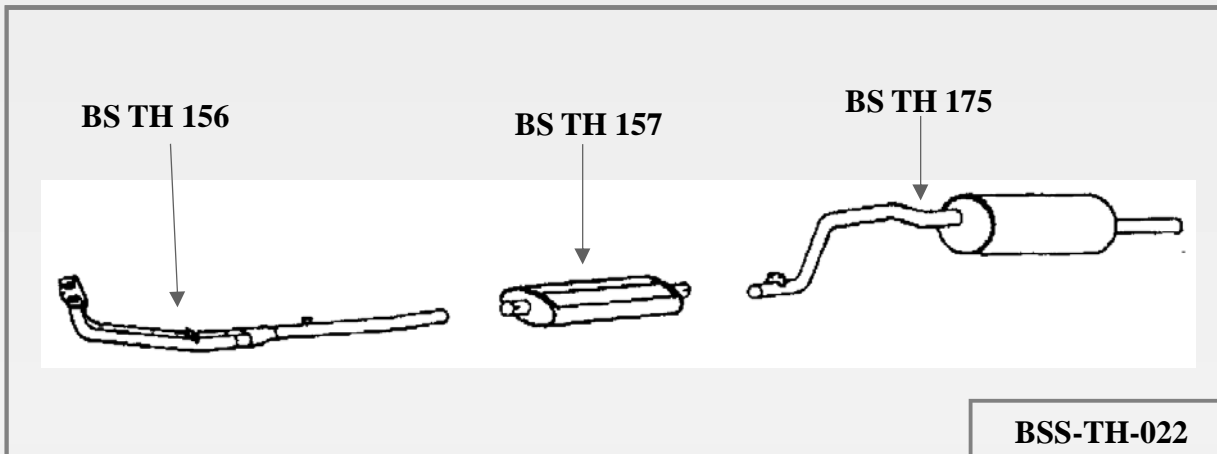



**STAINLESS STEEL EXHAUSTS**

West-Classic Tel: 0041 213 14 13 e-mail [west-classic@hotmail.com](mailto:west-classic@hotmail.com) Web: [www.west-classic.ch](http://www.west-classic.ch) / [www.west-motoren.ch](http://www.west-motoren.ch)

**TRIUMPH**

**STAG TYPE 35 AUTOMATIC 1970-1977**

FRONT PIPE RH	BS TH 111
FRONT PIPE LH	BS TH 112
SILENCER RH	BS TH 115
SILENCER LH	BS TH 116
LINK PIPE RH	BS TH 113
LINK PIPE LH	BS TH 114
TWIN TAIL PIPE	BS TH 117

**SYSTEM NUMBER** **BSS-TH-023**

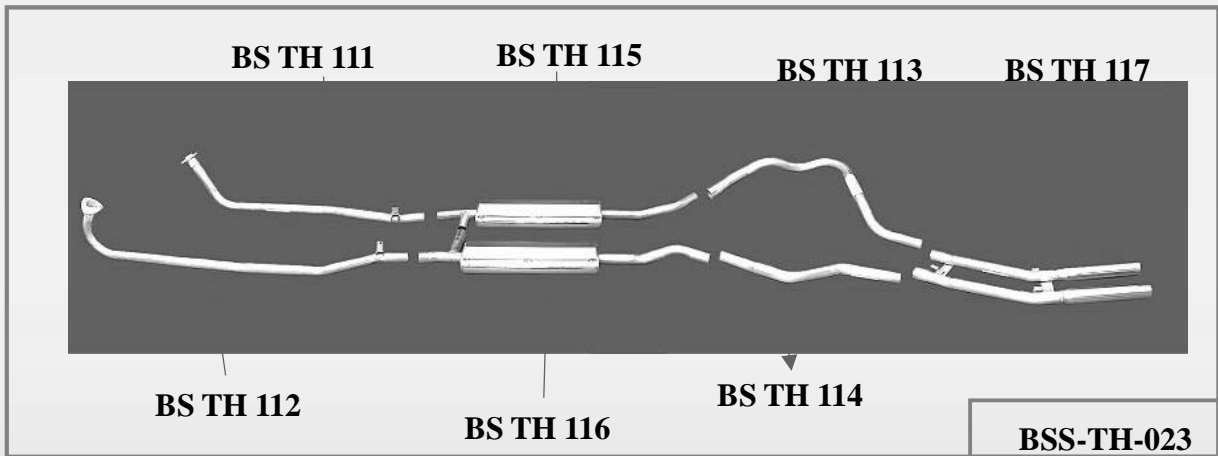



**STAINLESS STEEL EXHAUSTS**

West-Classic Tel: 0041 213 14 13 e-mail [west-classic@hotmail.com](mailto:west-classic@hotmail.com) Web: [www.west-classic.ch](http://www.west-classic.ch) / [www.west-motoren.ch](http://www.west-motoren.ch)

**TRIUMPH**

**STAG TYPE 65 AUTOMATIC 1970-1977**

FRONT PIPE RH  
FRONT PIPE LH  
SILENCER RH  
SILENCER LH  
LINK PIPE RH  
LINK PIPE LH  
TWIN TAIL PIPE

BS TH 128  
BS TH 129  
BS TH 115  
BS TH 116  
BS TH 113  
BS TH 114  
BS TH 117

**SYSTEM NUMBER**

**BSS-TH-024**

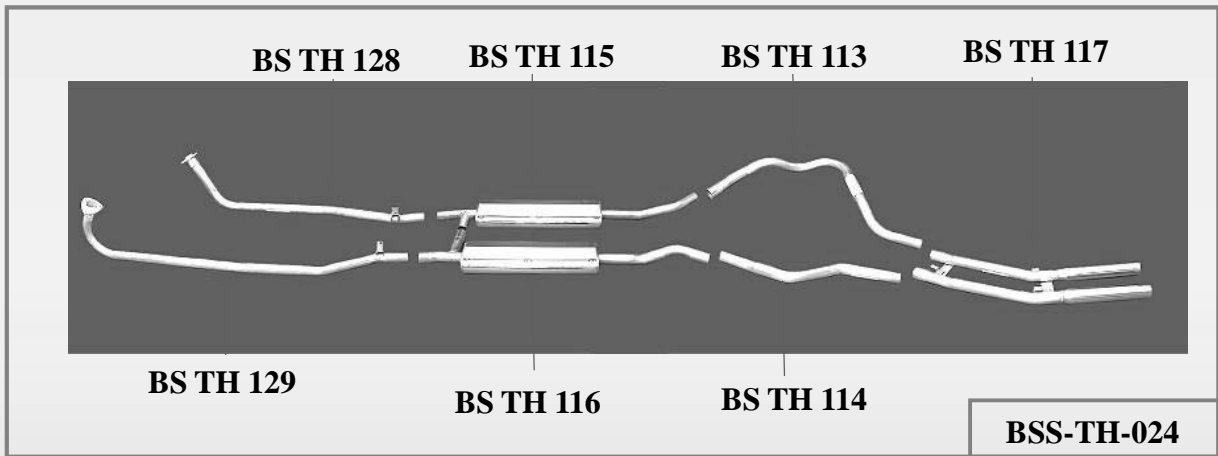



**STAINLESS STEEL EXHAUSTS**

West-Classic Tel: 0041 213 14 13 e-mail [west-classic@hotmail.com](mailto:west-classic@hotmail.com) Web: [www.west-classic.ch](http://www.west-classic.ch) / [www.west-motoren.ch](http://www.west-motoren.ch)

**TRIUMPH**

**STAG MANUAL WITH OVERDRIVE 1970-1977**

FRONT PIPE RH	BS TH 173
FRONT PIPE LH	BS TH 174
SILENCER RH	BS TH 115
SILENCER LH	BS TH 116
LINK PIPE RH	BS TH 113
LINK PIPE LH	BS TH 114
TWIN TAIL PIPE	BS TH 117

**SYSTEM NUMBER**

**BSS-TH-025**

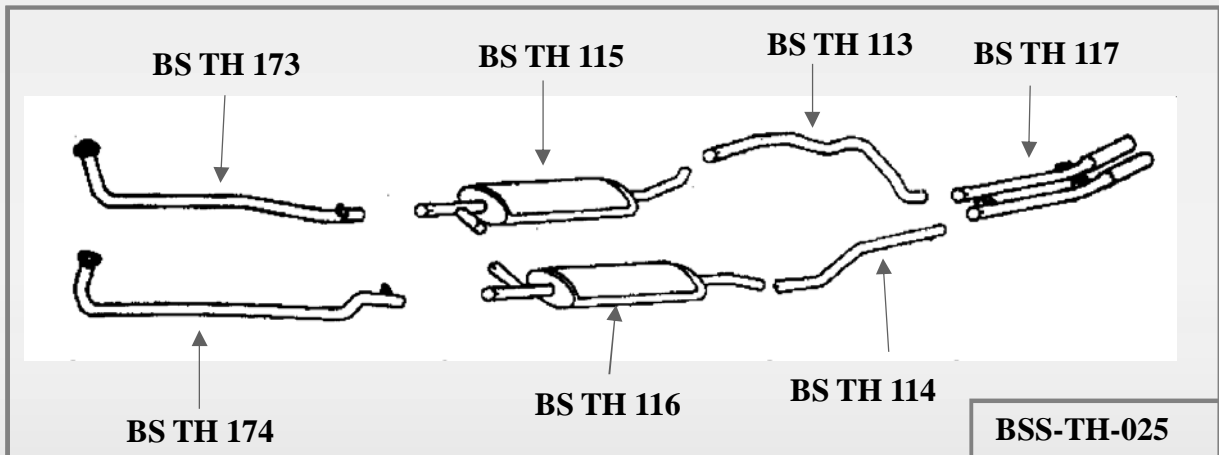



STAINLESS STEEL EXHAUSTS

West-Classic Tel: 0041 213 14 13 e-mail [west-classic@hotmail.com](mailto:west-classic@hotmail.com) Web: [www.west-classic.ch](http://www.west-classic.ch) / [www.west-motoren.ch](http://www.west-motoren.ch)

TRIUMPH

**TR5/6 SPORT SYSTEM – NFP TO FIT TO**  
**BRANCH MANIFOLD**

FRONT LINK PIPE OUTER	BS TH 076
FRONT LINK PIPE INNER	BS TH 077
REAR LINK PIPE	BS TH 115
TR5/6 LEFT HAND SPORT LINK PIPE	BS TH 116
RIGHT HAND REAR BOX SPORT	BS TH 113
LEFT HAND REAR BOX SPORT	BS TH 114

**SYSTEM NUMBER** **BSS-TH-028**

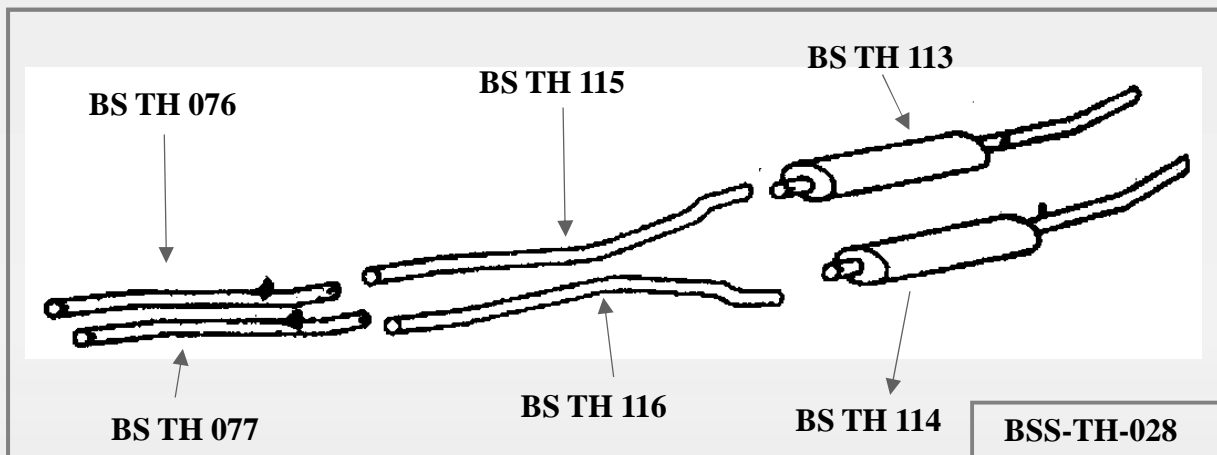



STAINLESS STEEL EXHAUSTS

West-Classic Tel: 0041 213 14 13 e-mail [west-classic@hotmail.com](mailto:west-classic@hotmail.com) Web: [www.west-classic.ch](http://www.west-classic.ch) / [www.west-motoren.ch](http://www.west-motoren.ch)

TRIUMPH

**HERALD SINGLE CARB COUPE**

HERALD SINGLE CARB FRONT PIPE  
MID BOX HERALD 948 1200/62  
REAR PIPE AND SILNECER

BS TH 024  
BS TH 025  
BS TH 026

**SYSTEM NUMBER**

**BSS-TH-029**

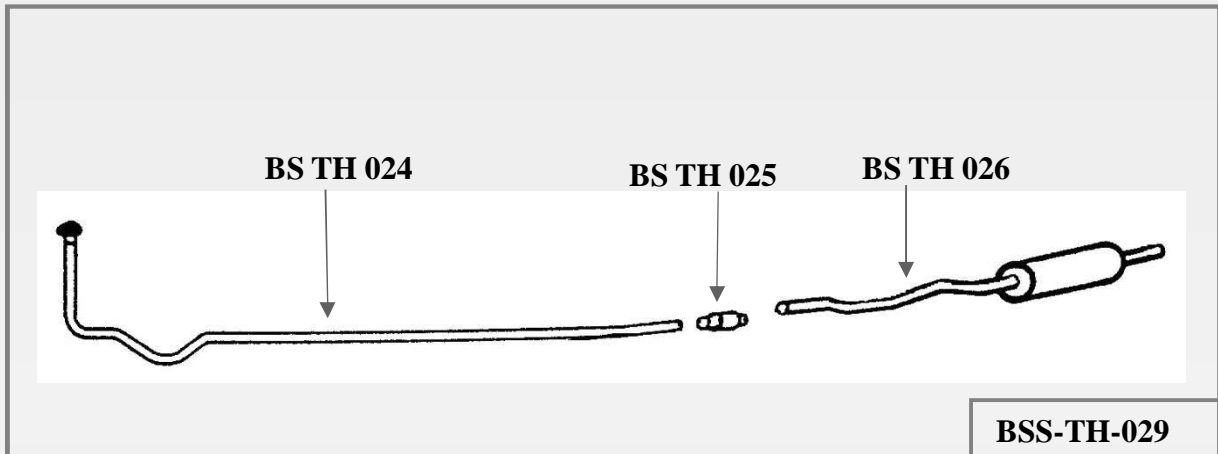





**STAINLESS STEEL EXHAUSTS**

West-Classic Tel: 0041 213 14 13 e-mail [west-classic@hotmail.com](mailto:west-classic@hotmail.com) Web: [www.west-classic.ch](http://www.west-classic.ch) / [www.west-motoren.ch](http://www.west-motoren.ch)

**TRIUMPH**

**HERALD TWIN CARB COUPE**

HERALD COUPE TWIN CARB FRONT PIPE  
MID BOX HERALD 948 1200/62  
REAR PIPE AND SILNECER

BS TH 027  
BS TH 025  
BS TH 026

**SYSTEM NUMBER**

**BSS-TH-030**

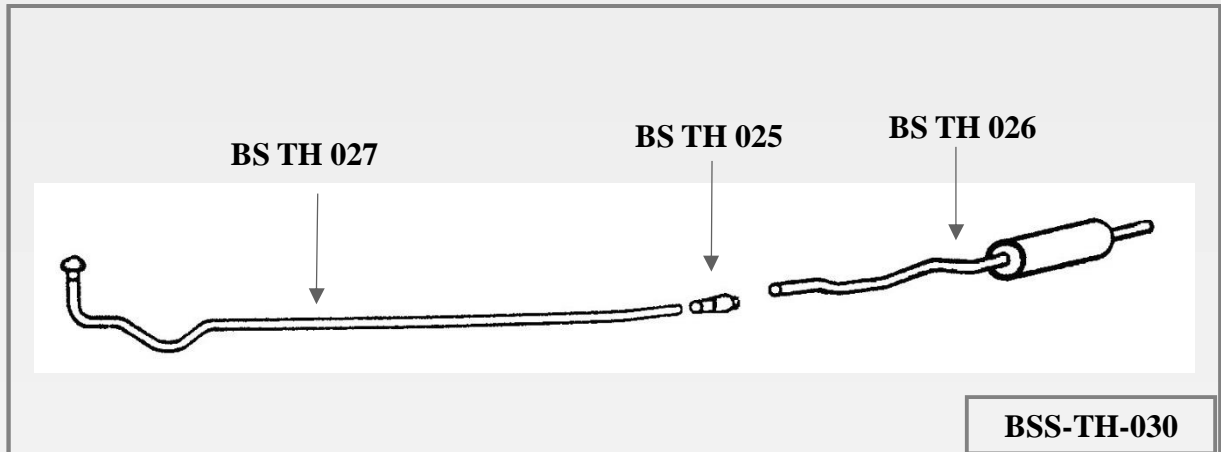

**BSS-TH-030**





**STAINLESS STEEL EXHAUSTS**

West-Classic Tel: 0041 213 14 13 e-mail [west-classic@hotmail.com](mailto:west-classic@hotmail.com) Web: [www.west-classic.ch](http://www.west-classic.ch) / [www.west-motoren.ch](http://www.west-motoren.ch)

TRIUMPH

**DOLOMITE SPRINT SPORT NFP**

DOLOMITE SPRINT SPORT MIDDLE  
DOLOMITE SPRINT SPORT REAR

BS TH 5421  
BS TH 5422

**SYSTEM NUMBER**

**BSS-TH-031**





**STAINLESS STEEL EXHAUSTS**

West-Classic Tel: 0041 213 14 13 e-mail [west-classic@hotmail.com](mailto:west-classic@hotmail.com) Web: [www.west-classic.ch](http://www.west-classic.ch) / [www.west-motoren.ch](http://www.west-motoren.ch)

**TRIUMPH**

**VITESSE 2000 MK II SPORTS SYSTEM**

Y FRONT PIECE

BS TH 293

SPORT BOX RIGHT HAND

BS TH 299-6

SPORT BOX LEFT HAND

BS TH 300-6

**SYSTEM NUMBER**

**BSS-TH-107**

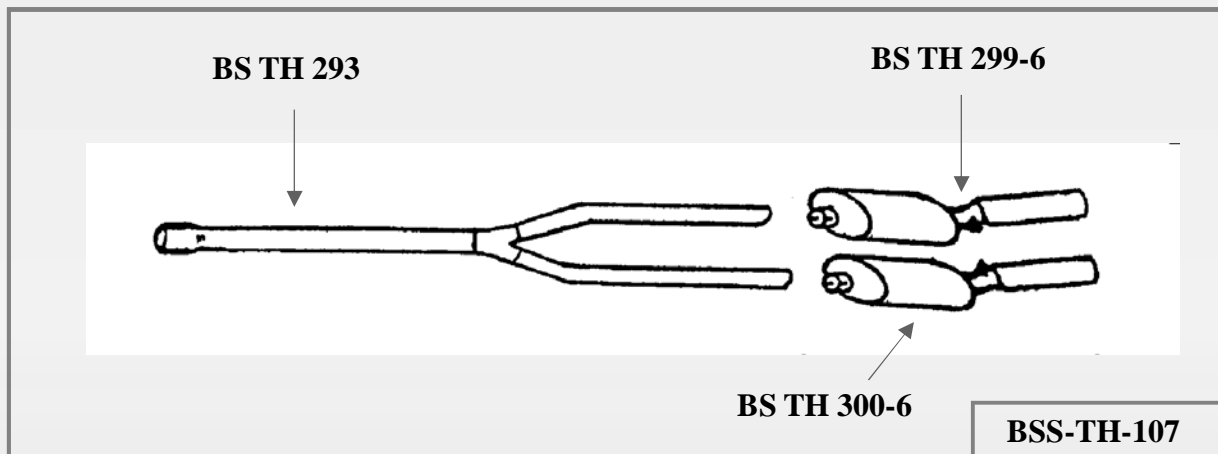



**STAINLESS STEEL EXHAUSTS**

West-Classic Tel: 0041 213 14 13 e-mail [west-classic@hotmail.com](mailto:west-classic@hotmail.com) Web: [www.west-classic.ch](http://www.west-classic.ch) / [www.west-motoren.ch](http://www.west-motoren.ch)

**TRIUMPH**

**SPITFIRE 4 MKI FULL SPORTS**

Y PIPE  
SPORT BOX RIGHT HAND  
SPORT BOX LEFT HAND

BS TH 295  
BS TH 299-4  
BS TH 300-4

**SYSTEM NUMBER**

**BSS-TH-108**

